

STATYS

63 - 100A Rack

Installation and operating manual 

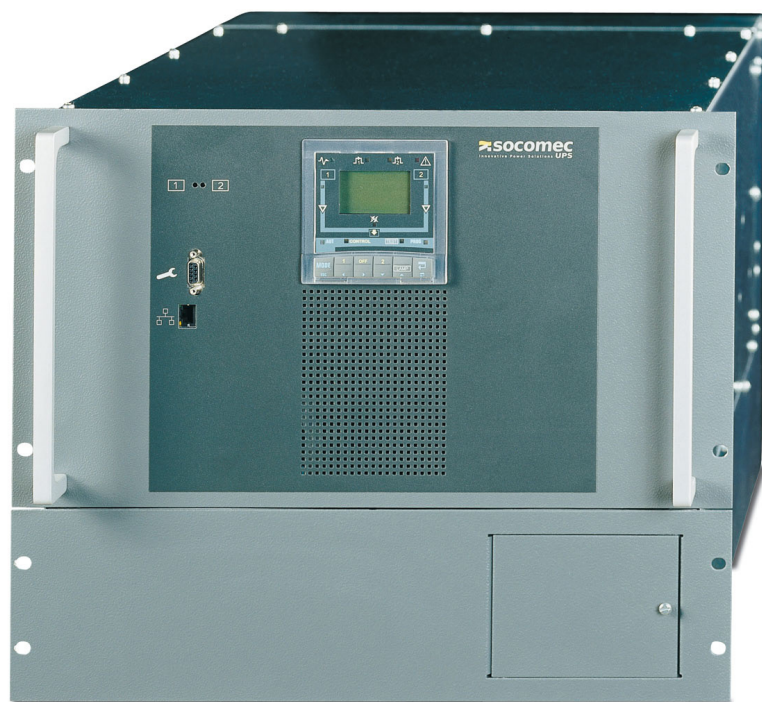

INDEX

1.	WARRANTY CERTIFICATE	1
2.	PRESENTATION	2
2.1.	FOREWORD	2
2.2.	THE ROLE OF STATYS	2
2.3.	OPERATING PRINCIPLE	2
3.	SAFETY INSTRUCTIONS	3
3.1.	PRECAUTIONS	3
3.2.	ELECTRICAL RISK	4
3.3.	RISK OF POWER CUT	4
4.	OVERVIEW	5
5.	UNPACKING	6
5.1.	PRECAUTIONS ON DELIVERY OF THE PRODUCT	6
5.2.	GENERAL RECOMMENDATIONS FOR INSTALLATION	6
6.	INSTALLATION	7
6.1.	SECURING THE RACK CABINET	7
6.2.	INSTALLING THE RAILS	7
6.3.	INSTALLING THE BASE	7
6.4.	INSTALLING THE POWER RACK	7
6.5.	COOLING	8
6.6.	MECHANICAL CHARACTERISTICS	8
6.7.	ENVIRONMENT	8
7.	CONNECTION	9
7.1.	ACCESS TO TERMINALS	9
7.2.	ELECTRICAL ENVIRONMENT	10
7.3.	SCHEMATIC DIAGRAM	10
7.4.	CABLE SIZING	11
7.5.	EARTHING DIAGRAMS	11
7.6.	CONNECTION KIT TNC DIAGRAMS	11
7.7.	CABLE ROUTING	12
7.8.	DEVICES FOR PROTECTING PERSONS AND PROPERTY	13
7.9.	CABLING PROCEDURE	14

8.	OPERATING MODES	15
8.1.	MANUAL TRANSFER	15
8.2.	AUTOMATIC TRANSFER	15
8.3.	AUTOMATIC RESTART FUNCTION	17
8.4.	OVERLOAD OPERATION	17
9.	MIMIC PANEL	18
9.1.	LCD AND LEDs	18
9.2.	PASSWORD MANAGEMENT	19
9.3.	KEYPAD	20
9.4.	DISPLAY	21
9.5.	OPERATING MODES	22
9.6.	ALARM MANAGEMENT	28
10.	COMMISSIONING	29
10.1.	START CONDITIONS	29
10.2.	ACTIVATION OF OUTPUT CONDUCTION	29
10.3.	SELECTING THE PREFERRED SOURCE	29
10.4.	LOAD SUPPLY	29
10.5.	MAINTENANCE BYPASS	30
11.	USE WITHOUT A POWER RACK	31
11.1.	REMOVING THE POWER RACK	31
11.2.	STOPPING THE LOAD WITHOUT THE POWER RACK	31
11.3.	RETURN TO BY-PASS	31
12.	COMMUNICATION INTERFACES FACILITIES	32
13.	ADVANCED DIAGNOSTICS AND PARAMETERS	33
14.	MAIN FEATURES	34
14.1.	ELECTRICAL CHARACTERISTICS - INPUTS	34
14.2.	ELECTRICAL CHARACTERISTICS - OUTPUT	34
14.3.	MECHANICAL CHARACTERISTICS	34
14.4.	ENVIRONMENT	34
15.	GLOSSARY	35
16.	APPENDICES	36
15.1.	PLAN: DIAGRAM	36

1. WARRANTY CERTIFICATE

The warranty terms are stipulated in the offer, by default the following clauses apply.

The SOCOMEC warranty is strictly limited to the product(s) and does not extend to equipment which may be integrated with this(these) product(s), nor the performance of this equipment.

The manufacturer guarantees its material to be free from manufacturing faults and defects in design, material or workmanship, subject to the limits set forth below.

The manufacturer reserves the right to modify the delivery with a view to fulfilling these guarantees or to replace defective parts. The manufacturer's warranty does not apply in the following cases:

- fault or defect in the design of parts added or supplied by the customer;
- fault due to unforeseen circumstances or force majeure;
- replacement or repair resulting from the normal wear of the modules or machinery;
- damage caused by negligence, lack of proper maintenance or misuse of the products;
- repair, modification, adjustment or replacement of parts performed by unqualified third parties or personnel without the express agreement of SOCOMEC.

The warranty period is twelve months commencing from the date of delivery of the product.

The repair, replacement or modification of the parts during the warranty period does not extend the warranty period.

In order to establish a valid warranty claim, the purchaser must notify the manufacturer in writing immediately after the discovery of any defects which are attributed to the material and provide any and all supporting evidence of the defects at the latest within eight days before the date of expiry of the warranty.

Defective parts which have been returned and replaced free of charge shall become the property of SOCOMEC.

The warranty is void if the purchaser has undertaken modifications or repairs on the devices on his or her own initiative and without the express consent of the manufacturer.

The manufacturer's responsibility is strictly limited to the obligations defined in this warranty (repair and replacement) excluding any other right to claim compensation or indemnity.

Any import tax, duty, fee or charge of any nature whatsoever imposed by European regulations or those of an importing country or of a transit country shall be paid by the purchaser.

All rights reserved



The liability of SOCOMEC in relation with the product subject of these instructions is as stated in the applicable conditions of sales agreed between SOCOMEC and its client

UK Socomec U.K. Limited, Unit 7-9 Lakeside Business Park, Broadway Lane, South Cerney, Cirencester,
CA Glos. GL7 5XL. www.socomec.co.uk

2. PRESENTATION

2. 1. FOREWORD

Thank you for choosing the STATYS Static Transfer System from SOCOMEC.

This equipment complies with the IEC 62310-2 product standard concerning Static Transfer Systems (STS).

This equipment conforms to EC directives applicable to this type of product. This conformity is indicated by the CE mark:



This equipment conforms to AS standards and bears the approval mark:



The regulations and standards applicable to the place of installation of the apparatus must also be observed to ensure the prevention of accidents.

2. 2. THE ROLE OF STATYS

STATYS watches permanently both sources of supply and the output to insure the automatic transfer of the use on the alternate source in case of failure of the priority source and to allow a return of the use on that source when she will be exploitable.

STATYS is defined by the rating of the current which passes through it by phase (in Amps), irrespective of other electrical characteristics. The power for a given rating is a function of the nominal voltage used.

2. 3. OPERATING PRINCIPLE

STATYS is an autonomous electrical device which permits the seamless transfer of the load between an alternate electrical source S1 and another alternate source S2 (see schematic diagrams § 7.3).

Under normal operation, STATYS supplies the load from the priority source. The priority source is selected by the user according to on-site restrictions.

Two transfer modes are possible:

- manual transfer mode, controlled by the operator locally or remotely by means of a BMS or other communicating system,
- automatic transfer mode, which occurs when an out-of-tolerance voltage is detected on the priority source. The break-before-make switching principle prevents source overlap.

NOTE: The priority source (source 1 or source 2) is selected using the keyboard and this selection is displayed on-screen.

3. SAFETY INSTRUCTIONS

3. 1. PRECAUTIONS

This document provides essential instructions regarding safety, handling and connections (see § 7)

Carefully read this manual before operating STATYS.

Keep this manual in a safe place for future reference.

Reference security information is in English language

For other languages please contact SOCOMEC or relevant distributor



The manufacturer will not be held liable for failure to follow the instructions in this manual or available at www.socomec.com

CAUTION

For optimal use, it is recommended to maintain the ambient temperature and humidity at the values specified by the manufacturer.

Do not expose STATYS to rain or any other type of liquid. Do not introduce foreign bodies into the unit.

WARNING

SOCOMECE maintains integral and exclusive ownership of its intellectual and industrial property rights regarding this document. Use of this document is limited to personal use by the recipient for the application specified by SOCOMEC. Any reproduction, modification or distribution of this document, whether in whole or in part, by any means whatsoever, is expressly prohibited without the prior written permission of SOCOMEC.

This document is not a specification. SOCOMEC reserves the right to modify the content of this document without notice.

This unit must be exclusively installed, commissioned and repaired by specialist technical personnel authorised by SOCOMEC.

The product which you have chosen taking into consideration its conditions of use, capacities and performance limits, is designed for commercial and industrial use only.

For use with so-called “critical applications”, the product may be required to comply with legal and regulatory obligations as well as specific local standards, and be adapted based on the recommendations of SOCOMEC. In all cases where the equipment is to be used for critical applications, you are advised to contact SOCOMEC in advance to confirm that the products are capable of meeting the required levels of safety, performance and reliability.

The term “critical applications” notably includes life support systems, medical applications, commercial transport, nuclear installations or any other system or application where the failure of the product is likely to cause substantial damage to persons or property.

3. 2. ELECTRICAL RISK

WARNING

All operations and maintenance must be performed by authorised personnel who have undertaken suitable training.

Scrupulously follow the operating or maintenance instructions described in this manual.

Take maximum precautions and determine which parts are live:

- by following the load diagrams,
- by checking the presence of power with a voltmeter, for example.

DANGER



The cabinet is permanently powered by sources 1 and 2.

Risk of electrocution !

- Only qualified and authorized personnel are allowed to intervene on the product.
- The instructions are valid in conjunction with the specific instructions of the product.
- The product is designed only for the application specified in the operating instructions.
- Accessories can be used with the product only if approved or specified by SOCOMEC.
- Before proceeding with the implementing, mounting, commissioning, configuration, cleaning, decommissioning, dismounting, wiring or maintenance operations, the product and the installation must be powered off. However, specific instructions for a product may allow live intervention under certain conditions, means, qualifications and authorizations.
- The product is not destined to be repaired by the user.
- Contact SOCOMEC for any questions regarding the disposal of the product.
- **Failure to follow the product instructions and this safety information may result in personal injury, electric shock, burns, death or property damage.**

In normal operating conditions, there is no danger for personnel handling this equipment.

3. 3. RISK OF POWER CUT

WARNING

Scrupulously follow the operating instructions described in this manual to prevent inadvertent power cuts which may pose a safety hazard to the user.

DANGER



Taking into account the presence of high leakage currents, it is essential to connect the ground cable before connecting the upstream and load sources.



Hazardous voltage may be present within STATYS after it is switched off. In fact, the power supply voltage remains present at the input of each static contactor



STATYS MUST be moved by at least two people. They MUST stand on either side of the unit according to the direction of movement.

4. OVERVIEW

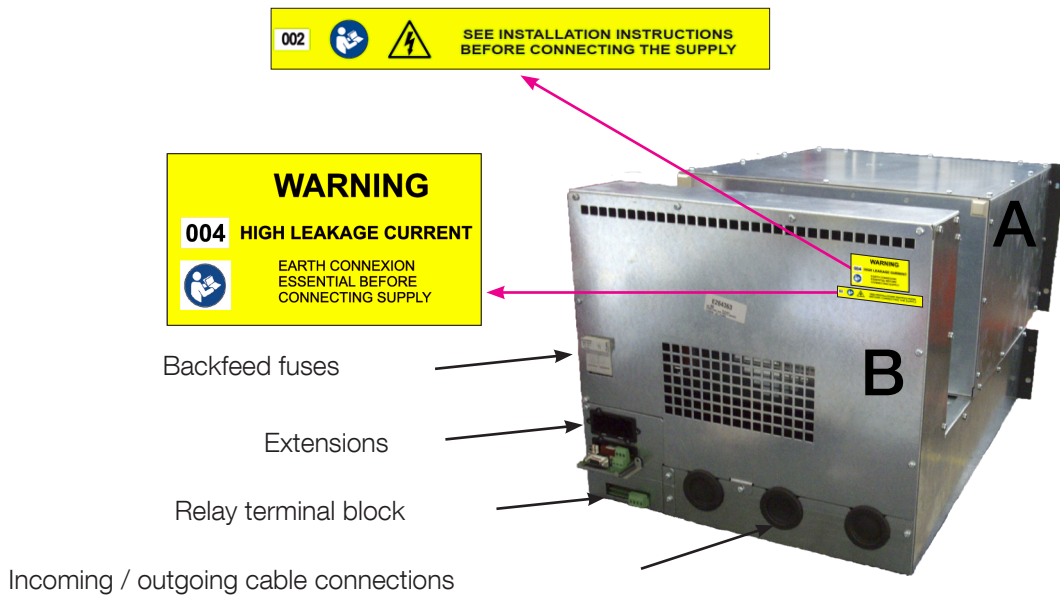
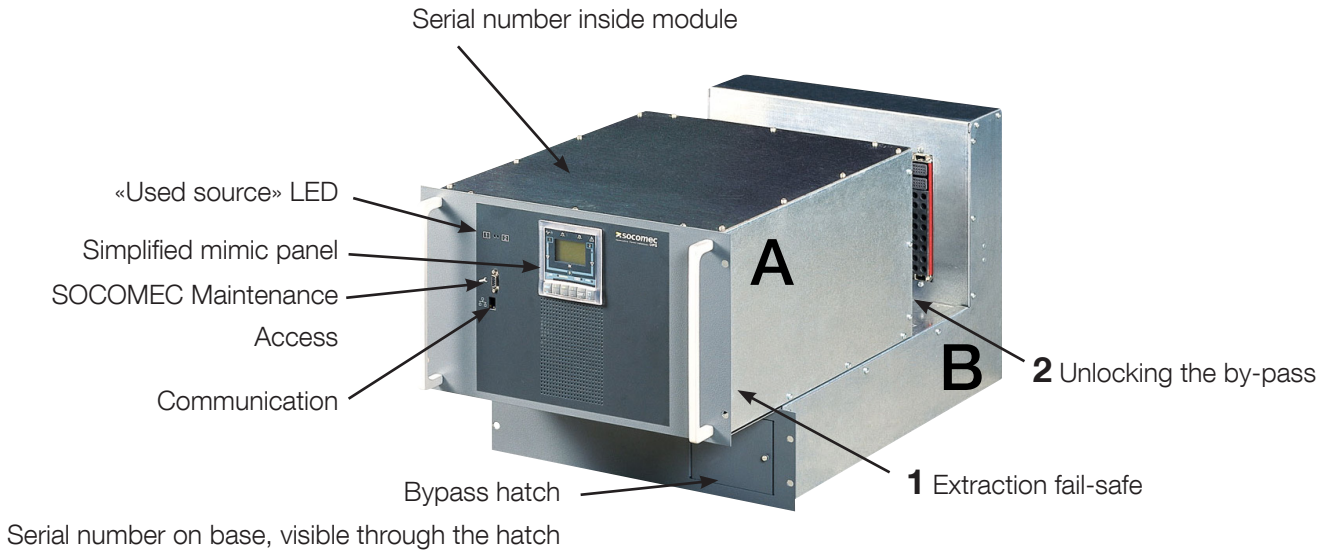

KEY:

- A = Pull-out power rack with switching electronics,
- B = Fixed base incorporating the connection and manual bypass components.

5. UNPACKING

5. 1. PRECAUTIONS ON DELIVERY OF THE PRODUCT

On delivery, check the condition of the packaging and ensure that the equipment casing is not damaged, dented or warped.

If necessary, report any damage or defects on the delivery note.

Carefully remove STATYS from its box, please bear in mind that the weight of the unit is not evenly distributed.

5. 2. GENERAL RECOMMENDATIONS FOR INSTALLATION

STATYS must be installed in an interior room which is:

- protected from humidity
- free of obstacles which may prevent natural ventilation,
- sufficiently ventilated to ensure a constant temperature to the equipment,
- clean, dry and dust-free,
- free of flammable vapour or corrosive smoke



In case of corrosive or industrial atmosphere environment, please, consult us.



Carefully read this manual before making the «source» input and «load» output connections.



This manual must be kept next to STATYS, so that the operator may refer to it at any time in case of need.



The electrical connection and all wiring operations must be performed by qualified personnel.



All packaging materials must be recycled in accordance with regulations in force in the country of installation.

6. INSTALLATION

6. 1. SECURING THE RACK CABINET



Since STATYS is a pull-out unit, the cabinet must be firmly secured to the floor!

6. 2. INSTALLING THE RAILS

Fasten the 2 rails (supplied with the product) inside the rack cabinet in order to support the base.

6. 3. INSTALLING THE BASE

Slide the base onto the 2 rails previously mounted and use the 4 holes in the front panel to fix the base to the cabinet using 4 screws.

6. 4. INSTALLING THE POWER RACK

STATYS is equipped with a device to protect against incorrect handling; check that the switch (behind the bypass cover) is set to position 0.

Slide the power rack onto the base and check that the rear section is squarely positioned against the base.

Fasten the front of the rack using 4 screws.

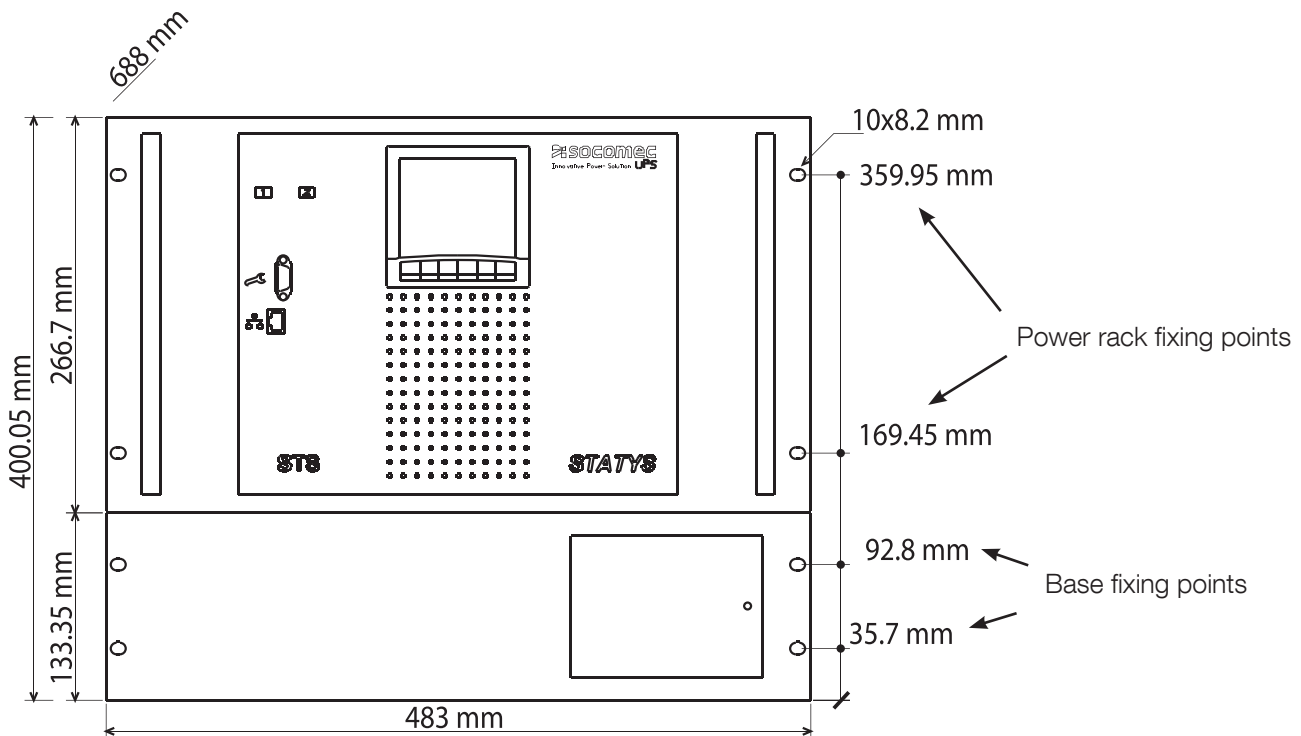

The rack cabinet must have a minimum depth of 800 mm

6. 5. COOLING



Ensure that ventilation of the rack cabinet enables the front of each STATYS to benefit from the adapted air socket (air flow rate and temperature) and for the rear side to have an adequate level of air extraction.



Check that the air flow is not obstructed

Rating	63A	100A
Type of cooling	Forced cooling	
Air flow (m ³ / h)	60	
Max. dissipation (W)	330	540

6. 6. MECHANICAL CHARACTERISTICS

Rating	63A	100A
Height	400 mm	
Width	483 mm	
Depth	648 mm without handle	
Weight	58 Kg	
Module	3 + 6	

6. 7. ENVIRONMENT

Rating	63A	100A
Operating temperatures	0 to 40 °C	
Storage temperatures	-20 to 70 °C	
Protection degree	IP 30	
Humidity	0 - 95%	
Altitude	< 1000 m without derating	
Noise level	42 dB(A)	

7. CONNECTION

7. 1. ACCESS TO TERMINALS

 **The cabinet must be accessible from the rear in order to connect STATYS**

Remove the 4 screws on the connection panel at the rear of the unit.

Remove the panel, thus providing access to the connection terminals of the incoming / outgoing power cables.

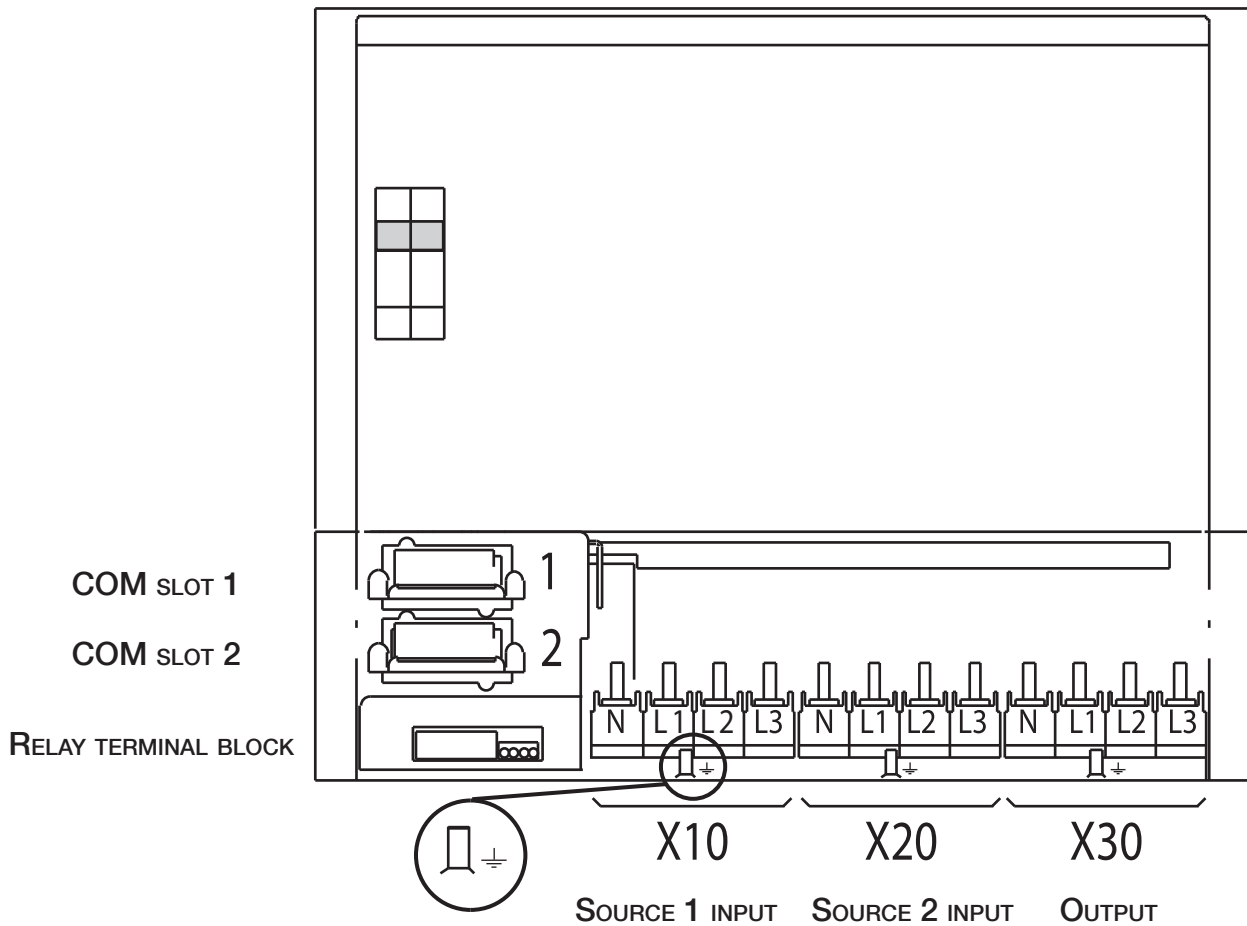

7. 2. ELECTRICAL ENVIRONMENT

7. 2.1. Electrical characteristics - inputs

Rating	63A	100A
Nominal voltages (source 1 / source 2)	208* / 220* / 380 / 400 / 415 / 440* V	
Nominal voltage tolerance	± 10% of Un (standard setting)	
Rated Frequency	50 or 60 Hz	
Frequency tolerance	± 2.5 Hz (can be configured up to ± 5 Hz)	
Current crest factor	≤3.5	

* optional

7. 2.2. Electrical characteristics - output

Rating	63A	100A
Nominal voltages	Same as input voltages	
Nominal frequency	Same as input frequencies	
Current	63A	100A
Current crest factor	≤3.5	
Overloads	See § 8.4	

7. 3. SCHEMATIC DIAGRAM

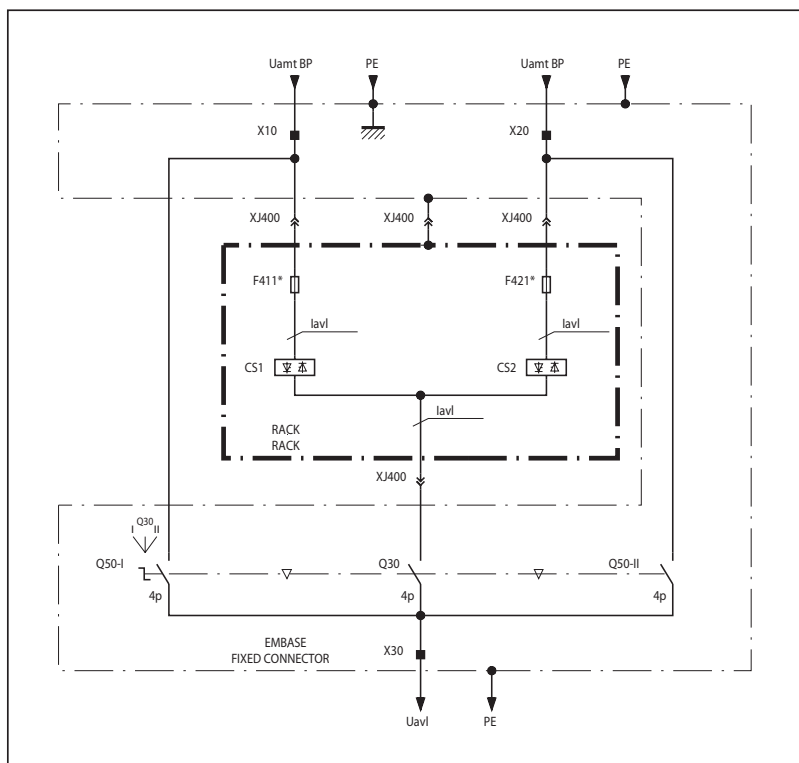

Description	Load
X10	Source 1 input
X20	Source 2 input
X30	Load output
Q30	Position 0 of Q50
Q50	Maintenance bypass
F4xx*	315A UR fuses
CSx	Switches

* according to model

7. 4. CABLE SIZING

The connection terminals are adapted for connection of copper cables. The connection terminals cannot receive tinned conductors. These terminals are spaced at 30mm intervals, which prevents accidental contact between 1 strand and a terminal

	Phases	Neutral	Earth
Connection	M6	M6	3 x M6
Max diameter (mm?)	50	50	50
Tightening torque (Nm)	4.5	4.5	4.5

 Failure to observe earthing procedures may lead to the risk of electric shock, or the risk of fire if an earth fault occurs.

 Remember to connect the earth at the marked point 

 Earth connections must be in compliance with local regulations and applicable standards.

 The neutral is not always wired and depends on the neutral condition of the installation.

7. 5. EARTHING DIAGRAMS

The STATYS range is compatible with all earthing systems (IT consult us). Nevertheless you should ensure that you have a suitable safety device (3-pole breaker or 4-pole breaker) installed.

7. 6. CONNECTION KIT TNC DIAGRAMS

Supplied on request, these 3 brackets enable the neutral terminal of the sources and output to be connected to a ground terminal directly on the connection terminals.

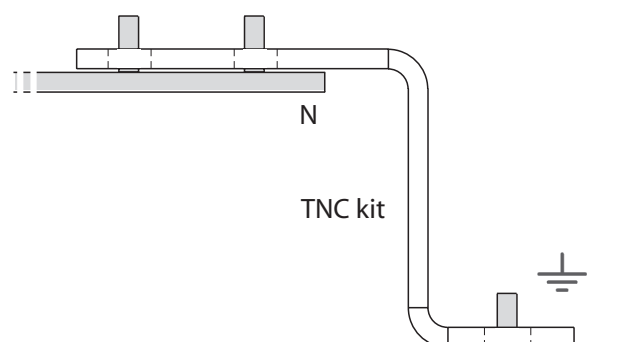

7. 7. CABLE ROUTING

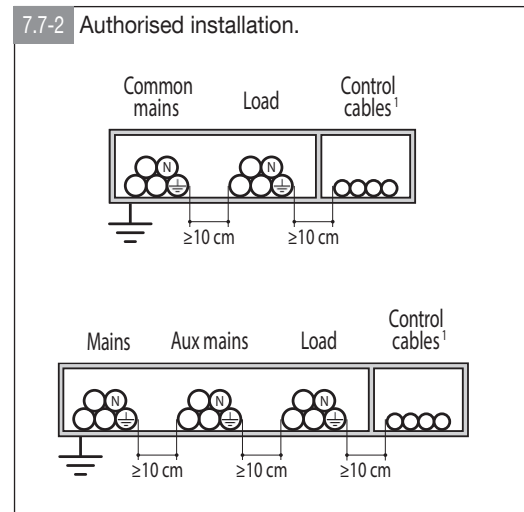
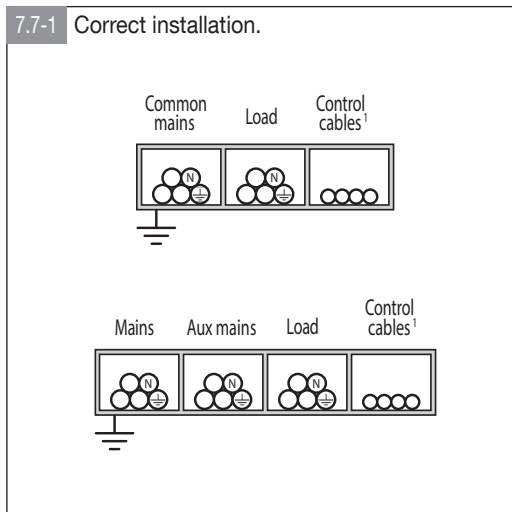

Control cables¹: connections between the cabinets and each unit, alarm messages, remote mimic panel, BMS connection, emergency stop, connection to breaker components...

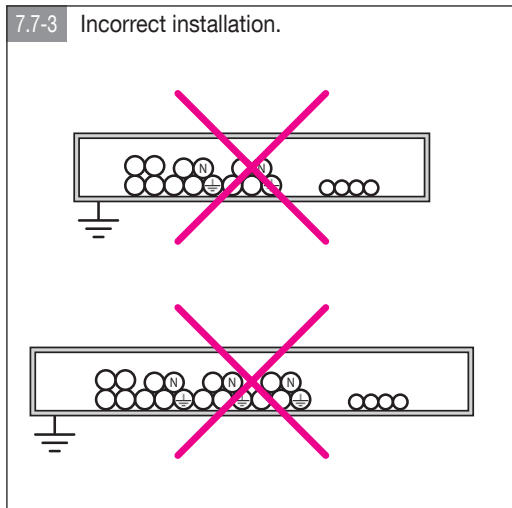

Power cables and control cables must never be installed in the same raceway



Power cables near to sensitive equipment must not be exposed to electromagnetic fields.

7. 8. DEVICES FOR PROTECTING PERSONS AND PROPERTY

7. 8.1. Backfeed protection

In order to comply with the IEC 62310-1 & IEC 62310-3 Standard, STATYS is fitted with a control for backfeed protection devices. In case of default on one input, STATYS delivers a voltage signal on terminal block XB2 (see § 12) to triggers the upstream protection devices by means of a pulse-type shunt trip coil.



It is a phase to phase voltage



Backfeed cabling is mandatory



Upstream protection devices triggered by the shunt trip coils must be marked with a warning label



SOCOMECC declines all responsibility if the signal for triggering upstream protection devices is not connected up.

7. 8.2. Internal protective device

Depending on the STATYS model ordered, an internal protective device may be present:



If possible, replace using an identical model of the same brand.

In any case the neutral is not protected (never broken).



The internal protective does not provide external upstream protection.

7. 8.3. External upstream protection

These protective devices need to be selected and configured taking into account the size of the STATYS unit, the installation and the diameter of cable used.



Neutral rating if the load is non-linear (x 1.7).



The installation's short-circuit current must not exceed that permitted by STATYS (see § 8.4)

If a differential switch is installed on the mains power switch, it must be inserted upstream from the distribution panel; it must be type B

7. 9. CABLING PROCEDURE

7. 9.1. Preliminary checks

Ensure that STATYS is correctly installed in its final position.

Check that the installation is isolated.

Set all switches to position 0.

7. 9.2. Cabinet cabling

Remove the protective devices to gain access to the power connections.

Check that the ground connector is clamped in firm contact with ground.

Check that the other installation devices are securely attached to this ground.

The diameter of the cable must comply with table § 7.4.

Fit a cable linking the ground connector to the PE terminal block.

Wire the source 1 phases on terminal block X10. Pay attention to the direction of rotation of the phases.

Wire the source 2 phases on terminal block X20. Pay attention to the direction of rotation of the phases.

Wire the output on terminal block X30. Pay attention to the direction of rotation of the phases.



Comply with the specified neutral-to-neutral connection.

Note: Whether or not the neutral is wired on terminal block depends on your neutral condition.



Ensure that phases are correctly configured between source 1 and source 2.

Refit the protective panels.

8. OPERATING MODES

8. 1. MANUAL TRANSFER

The user is able to control the transfer of the load from one source to another, both via the keypad and via communication (see «communication interface» § 12).

Manual transfer does not disturb the supply to the load.

If the synchronisation conditions are not met after 30 seconds (factory default setting), an asynchronous transfer occurs, if authorised, otherwise the request is cancelled.

If the transfer cannot take place (for example, 2nd source out of tolerance), the following icon appears:

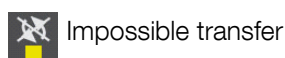

Note: The alarm will shut off automatically when normal conditions are restored.

8. 2. AUTOMATIC TRANSFER

Automatic transfer occurs in the event of a voltage drop, frequency drop or when the preferred source is unavailable. It does not interrupt the supply to the load. Automatic transfer switches the supply from the preferred source to the alternate source. Once the preferred source is re-established, the system automatically returns to this source after a time delay, which can be configured by the user.

The parameters that define the quality thresholds of the source and the automatic return can be adjusted in programming mode (see § 9.5.4)

To ensure totally secure transfer, STATYS continuously monitors the presence of the alternate source.

If the alternate source is unavailable (or if the voltage exceeds the preset tolerances), the transfer function is inhibited. STATYS immediately raises an alarm to warn the operator that the transfer is no longer possible.

Automatic return from the alternate source back to the preferred source may also occur following a manual transfer.

In the event of a short circuit at the output of the supplied equipment, the transfer function is inhibited. This stops the short circuit from being transmitted along the other track and thus prevents the other source from being interrupted.

Two types of transfer may occur, synchronous or asynchronous, according to the source synchronisation status and the hardware configuration.

SYNCHRONOUS TRANSFER

Synchronous transfer occurs automatically when the two sources S1 and S2 are deemed to be synchronised, e.g. when their phase deviation is within the tolerance window (standard $\pm 10^\circ$). In this case, switching the source does not alter the phase.

If the phase deviation exceeds this tolerance window, synchronous transfer is inhibited and automatic changeover to the other source will not be possible. However, the transfer may in any event be executed in these conditions if the system is configured for synchronous/asynchronous transfer.

NOTE: STATYS is configured for synchronous/asynchronous transfer by default.

It may be configured to «synchronous only» transfer for applications which are sensitive to phase shifts (advanced parameters, see §13).

Most information processing equipment, servers, computer... are impervious to significant phase variations.

ASYNCHRONOUS TRANSFER

Automatic asynchronous transfer occurs only if it is authorised by the software configuration (standard factory configuration, advanced parameters see §13) and if the sources S1 and S2 are not synchronised, e.g. their phase deviation exceeds the tolerance window. In this case, switching the source may produce a significant phase variation during the changeover.

This type of transfer allows for automatic load changeover between sources which are not permanently controlled, or which are unusually out of phase, thereby maximising the security of the power supply.

8. 3. AUTOMATIC RESTART FUNCTION

Following the total unavailability of both sources and if STATYS is in conduction state on one of the two sources, an automatic restart and conduction occurs on the return to one of the 2 sources.

The supply is re transferred automatically onto the preferred source as soon as this source becomes available.

The automatic restart function is configurable and is set to OFF by default.

8. 4. OVERLOAD OPERATION

The STATYS overload control is based on the principle of filling a reservoir more or less rapidly, depending on the measured load rate.

Each STATYS string has its own reservoir.

When STATYS is in overload, an «OVERLOAD ALARM» message appears and the «GENERAL ALARM» is triggered.

TYPICAL OVERLOADS GUIDE:

The increment follows the guide below:

Overload	Time
110%	60 min
125%	10 min
150%	2 min
200%	20 seconds

Note: These values may vary as a function of the rating (in amperes), the protection index and the ambient temperature.

9. MIMIC PANEL

9. 1. LCD AND LEDs

9. 1.1. Presentation

The mimic panel consists of:







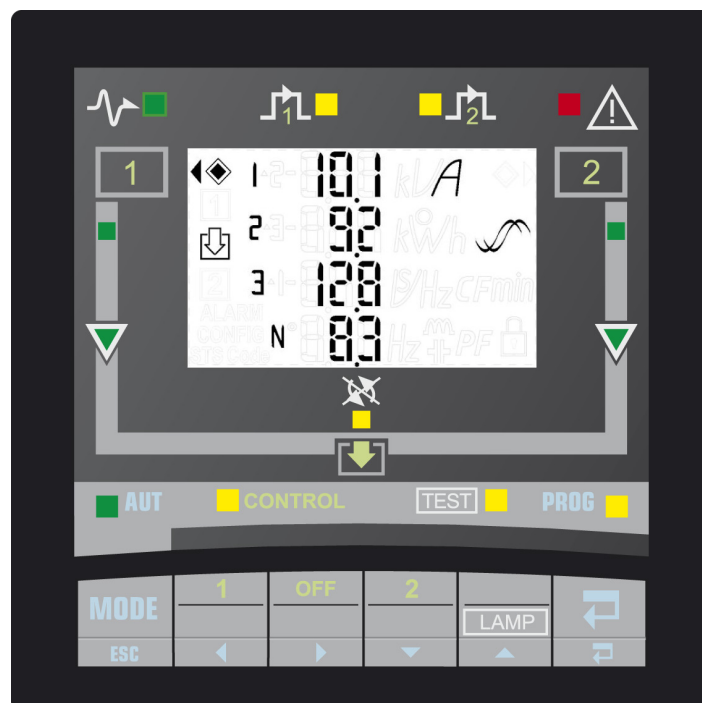



- an LCD screen permitting:
 - display of electrical magnitudes of an input or output (in AUT mode)
 - activation of system controls (in CONTROL mode)
 - display of maintenance codes (in TEST mode)
 - programming of the device (in PROG mode)

- 13 LEDs indicating:
 - the different operating states
 - the mimic panel showing the power flow
 - the system's current mode

- 6 keys used for system management.



9. 1.2. Meaning of leds

	ON	BLINKING	OFF
	Load supplied by STATYS	Output shutdown imminent	Output not supplied by STATYS
	Output supplied directly by source 1	/	/
	Output supplied directly by source 2	/	/
	General Alarm	Critical alarm	No alarm active
	Source within tolerances	Source outside tolerated range	Source absent
	Conduction path	Path outside tolerated range	No conduction
	Transfer locked	Switchback impossible	Transfer possible
   	Selected mode	Mode awaiting selection	/

9. 2. PASSWORD MANAGEMENT

Two levels of protection:



«User» password: provides access to control mode and user parameters settings (user access). Disabled by default (set to __ _), it can be configured from 000 to 999 and __ _.

«System» password: provides access to user and system parameter settings. The default setting is 000, it may be configured from 000 to 999.

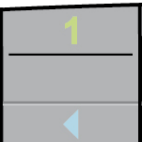
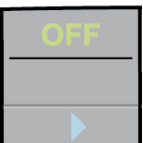
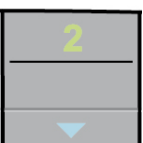
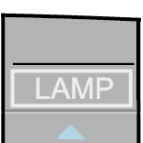

When the device is in standby mode, the password is invalidated.

9. 3. KEYPAD

KEY	FUNCTION
	Accesses different menus (AUT, CONTROL, TEST and PROG)
	Once in a menu, cancels an ongoing command
	In CONTROL mode, activates source 1 conduction
	Scrolls display, menu or digit
	In CONTROL mode, stops conduction
	Scrolls display, menu or digit
	In CONTROL mode, activates source 2 conduction
	Modifies the blinking value
	In TEST mode, launches a full display test (LEDs, screen, buzzer)
	Modifies the blinking value
	Acknowledges alarm
	Validate or store





The buzzer emits a short beep whenever a key is pressed

9. 4. DISPLAY

The LCD screen displays:

The following icons (irrespective of which mode is selected):

 or  = indicates the preferred source



Off = synchronous sources

Blinking = sliding sources

On = permanently asynchronous sources



= Password protection is ON

Electrical magnitudes:



Voltages and frequency of each source on 1 page marked with the number **1** or **2** to indicate the source in question

Voltages and frequency (1 page), current (1 page), power (kW and kVA, only 4 Wires), power factor and crest factor (CF) (1 page) and load rate (Lr and %) (1 page) of the output, marked with the icon 

If there is no output load, the display switches alternately from source 1 to source 2.

If there is a load at the output, only the output pages are displayed.

An alarm message may appear if an alarm is raised (see «alarm» chapter).

This standard display may be temporarily fixed on one page using the buttons  and 



The display goes into standby mode (backlight OFF) after 5 minutes of keypad inactivity.

9. 5. OPERATING MODES

there are 4 modes:

- automatic (AUT)
- control (CONTROL)
- test (TEST)
- programming (PROG)



Whatever the mode selected, STATYS operation remains prioritised.

Press the  key to select the next mode (the corresponding LED will blink), press the  key to enter the selected mode.



If the keypad is not touched for 30 seconds, the system returns to automatic mode.

9. 5.1. Automatic mode

This is the default mode. In this mode the LCD screen displays the electrical magnitudes of the inputs or of the output (see «display» chapter), as well as alarm messages (see «alarm» chapter).



The display can be fixed on one page using the keys  and .



9. 5.2. Control mode







This mode is accessed by entering the «user» password (if defined)

The display is identical to the automatic mode display (but cannot be fixed on one page). The device waits for the conduction state to be changed manually:

Stop conduction press the  (OFF) key, the «ld off» indicator blinks, press the  key, then this sequence a second time to validate this choice or press the  key to cancel the command.

Activate source 1 conduction press the  key (1), the message «use S1» blinks, press the  key to validate this choice or press the  key to cancel the command.

Activate source 2 conduction press the  key (2), the message «use S2» blinks, press the  key to validate this choice or press the  key to cancel the command.



 **These changeovers are performed whether the sources are synchronous or asynchronous, unless the factory setting of the device is changed to «synchronous only» mode (no asynchronous transfer, settings accessible in advanced parameters, see §13).**



 **If the sources are sliding, the appliance requests a «transfer on the fly»**



Transfer on the fly

If, during a conduction activation request, the sources are sliding, a «fly» message blinks along with the phase shift value.

The user can then:

- wait for the transfer to occur automatically once the 2 sources become synchronous,
- force the transfer (if the device configuration authorises an asynchronous transfer) by once more pressing the key for the desired source. The message «frc trf» (force transfer) blinks on the last line («fly» no longer blinks), press the  key to validate the forced transfer request (cancel using the  key and thereby return to the «fly» message),

To exit this mode, press the key for the source in conduction state once more. The message «esc» then appears. Validate it using the  key or cancel it using the  key.



Stop automatic switchback when the device is waiting for phase synchronisation, press the key for the alternate source ( or ).

The message «end asb» appears

9. 5.3. Test mode

This mode enables maintenance codes to be displayed in the form of pages marked with a number
For each maintenance page the following information appears:

- on the bottom line, the message «STS Code N° xxx» where xxx corresponds to the page n°,
- on the top two lines, 4 hexadecimal digits corresponding to the maintenance code.

the page is changed using the keys  and 

Pressing on the  key launches a complete mimic panel test by:

- Switching on all LEDs,
- Displaying all LCD segments,
- Operating the buzzer.



This mode does not interrupt the normal operation of STATYS

9. 5.4. Programming mode



This mode is accessed by entering a password:

If the «user» password is inputted, only «user» parameters may be configured.

If the «system» password is inputted, all parameters could be modified.

Choice of preferred source (user access)

Display: PS

Default value: S1

Possible choice: S1 or S2

Modbus link configuration (user access)

Display: mod bus

Slave number

Display: sla nb

Default value: 1

Possible choice: 1 to 255

Link speed

Display: bds

Default value: 9600

Possible choice: 2400, 4800, 9600 or 19200

Link parity

Display: par

Default value: no

Possible choice: odd, eve (even) or no

Timestamp (user access)

Display: day time

Date

Display: day

Default value: today

Possible choice: day-month-year with day from 1 to 31, month from Jan to Dec and year from 00 to 99

Time

Display: time

Default value: current hour

System configuration (System access)

Display: sys cfg

Password configuration

Display: pin code

User password

Display: usr pin (user pin)

Default value: _ _ _

Possible choice: 000 to 999 (000 = no password)

System password

Display: sys pin (system pin)

Default value: 000

Possible choice: 000 to 999

Remote control (System access)

Display: rem ctl (remote control)

Default value: en

Possible choice: en (enable) or dis (disable)

Sensitivity threshold* (System access)

Display: sen (sensitivity)

Default value: std

Possible choice: L for «low», std for «standard», H for «high» and cus for «custom» (configuration via PC link)

*Values used to carry out transfer (if authorised):

Low Sensitivity:

- the RMS voltage value exceeds the rated value by +/- 15%,
- The frequency exceeds the rated value by +/- 4 Hz,
- instantaneous voltage (1ms transient) drops to 40% below the RMS rated voltage.

High Sensitivity:

- the RMS voltage value exceeds the rated value by +/- 5%,
- The frequency exceeds the rated value by +/- 1 Hz,
- instantaneous voltage (1ms transient) drops to 15% below the RMS rated voltage.

Standard Sensitivity:

- the RMS voltage value exceeds the rated value by +/- 10%,
- The frequency exceeds the rated value by +/- 2 Hz,
- instantaneous voltage (1ms transient) drops to 25% below the RMS rated voltage.

Automatic load resupply (System access)

Display: aut on (automatic on)

Use of automatic resupply

Display: aut on (automatic on)

Default value: no

Possible choice: yes or no

Delay before automatic resupply

Display: dly (delay)

Default value: 0 seconds

Possible choice: 0 to 65535 (if aut on = yes)

Automatic retransfer to the preferred source (System access)

Display: aut sb (automatic switchback)

Use of automatic switchback

Display: aut sb (automatic switchback)

Default value: no

Possible choice: yes or no

Delay before automatic switchback

Display: dly (delay)

Default value: 3 seconds

Possible choice: 0 to 65535 (if aut sb = yes)

Nominal voltage (System access)¹

Display: un (Un)

Default value: nominal value measured by the equipment

Possible choice: 100V to 499V

Nominal frequency (System access)¹

Display: fn (F)

Default value: nominal value measured by the equipment

Possible choice: 50 or 60 Hz

¹values used to calculated upper and lower limits.

9. 6. ALARM MANAGEMENT

When an alarm is triggered (see alarms table), a flashing message (and his number) appears on the screen regardless of which mode is in use. If the alarm is critical the LED flashes, otherwise it is lit continuously. In addition to the message and the LED warning, a buzzer will sound.

When the  key is pressed, the alarm is acknowledged and the buzzer is silenced, the display remains fixed (it shows the display pages) but the LED remains ON

These different alarm displays will disappear when the alarm disappears.

In the case of multiple alarms, only the most important one will be displayed and the buzzer will sound until the last alarm is acknowledged.

Name	Message	N°	Meaning
Imminent stop	imm stp	0	Imminent conduction shutdown
Output Isc detection	Out isc	1	Output in short circuit
Manual By-pass	mnt bp	2	Manual bypass on
Overload	I max	3	Overload at the output
Consecutive detections	Con det	5	Too many consecutive transfers
Auto re transfer impossible	sb imp	6	Impossible Switchback
Transfer impossible	trf imp	7	Impossible Transfer
PowerPath 1 deteriorated	pa1 at	9	Input 1 out of tolerance
PowerPath 1 in short circuit	pa1 sc	10	Input 1 in short circuit
PowerPath 1 in failure	pa1 out	11	Input 1 in failure
PowerPath 2 deteriorated	pa2 at	13	Input 2 out of tolerance
PowerPath 2 in short circuit	pa2 sc	14	Input 2 in short circuit
PowerPath 2 in failure	pa2 out	15	Input 2 in failure
Backfeed S1 protection open	bf opn	16	Source 1 protection open
Backfeed S2 protection open	bf opn	17	Source 2 protection open
Ambient temperature max	tmp max	18	Max temperature reached
Insufficient resources	ins res	20	Insufficient resources
Preventive alarm	prevent alm	25	Preventive alarm
Configuration alarm	config alm	26	Problem with the settings and parameters
Control Panel alarm	hmi	27	Communication with screen lost
Electronic	eln	28	Electronic problem
Custom input alarm	cus in	29	Custom alarm
Maintenance alarm	mainten alm	30	Maintenance alarm
General Alarm	gen alm	31	General Alarm

10. COMMISSIONING

10. 1. START CONDITIONS

The 3-way switch is set to position «0», Source 1 and Source 2 voltages are present, the mimic panel will then be activated.

10. 2. ACTIVATION OF OUTPUT CONDUCTION

According to the autorestart configuration (see § 9.5) conduction can then be activated on the output. The user can then establish conduction from the alternate source, or stop conduction.

10. 3. SELECTING THE PREFERRED SOURCE

Note: According to the factory default setting, the preferred source is source 1.

Under normal operation, the load is supplied by the preferred source.

REMINDER: automatic transfer switches the supply from the preferred source to the alternate source. It is therefore important that the user defines the preferred source.

The preferred source is selected in «programming» mode (see § 9.5.4).

10. 4. LOAD SUPPLY

If conduction is not activated, the user may force the conduction (see § 9.5.2 Controls mode).

10.5. MAINTENANCE BYPASS

STATYS is equipped with two bypasses which enable it to directly supply the load from source 1 or 2 without interrupting your application's power supply
At that point, the power rack can be pulled out.

This function is entirely secure, the switches are equipped with mechanical and electronic locks to minimise the risk of human error.

Nevertheless you should observe the follow instructions:

The bypass is initiated using a 3-way switch:

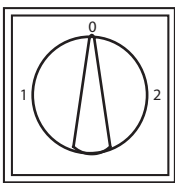

In position 0 = normal operation

the power rack cannot be pulled out (mechanical lock).
the load is powered by CS1 or CS2

Activate bypass 1: Ensure that STATYS is on source 1 (CS1 is enabled)

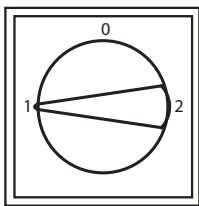

In position 1 = bypass to source 1

the load is directly supplied by source 1
the power rack can be pulled out.

Return to normal operation (position 0): Ensure that STATYS is on source 1 (CS1 is enabled)

Activate bypass 2: Ensure that STATYS is on source 2 (CS2 is enabled)

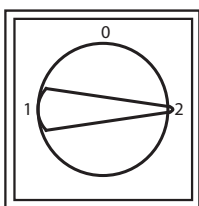

In position 2 = bypass to source 2

the load is directly supplied by source 2
the power rack can be pulled out.

Return to normal operation (position 0): Ensure that STATYS is on source 2 (CS2 is enabled)



Do not change the position of the switch when the power rack is removed, as the critical load would no longer be supported

11. USE WITHOUT A POWER RACK

When operating normally, the STATYS by-pass must never be operated unless a power rack is fitted. However, it is possible to operate the by-pass after the module has been removed.



This operation must always be carried out by trained personnel who have been provided with appropriate personal electrical protection equipment: only then can electrically 'live' components be accessed!



This operation cuts the power supply / load!

11. 1. REMOVING THE POWER RACK

A mechanical failsafe prevents the rack from being removed completely in a single operation: once the rack reaches its limit stop, press it to remove the rack completely from its mounting (reference point 1, refer to general view § 4).



Bearing in mind the weight of this equipment (58 kg), this operation must be performed by two people (i.e. this is a 'two-man job').

11. 2. STOPPING THE LOAD WITHOUT THE POWER RACK

STATYS is on by-pass, load is powered, rack is removed.

You wish to stop the power supply to the load:

- Enable the unlocking operation (reference point 2, see general view § 4)
- While the unlocking operation is enabled, move the by-pass switch to position 0.
- Releasing the unlocking operation

11. 3. RETURN TO BY-PASS

This return to by-pass involves moving the by-pass switch back into position 1 or 2:

- Enable the unlocking operation (reference point 2, see general view § 4)
- While the unlocking operation is enabled, move the by-pass switch to position 1 or 2.
- Releasing the unlocking operation



The move to by-pass powers the load if the source is present.



Pay attention: The rack cannot be replaced in its mounting unless the STATYS unit is on its by-pass setting.

12. COMMUNICATION INTERFACES FACILITIES

STATYS is equipped as standard with:

- (on front panel) one Ethernet port which allows the use of the SNMP protocol, sending of emails following alarm activation, and integrated Web page browsing
- (on the rear panel), one terminal block giving access to:

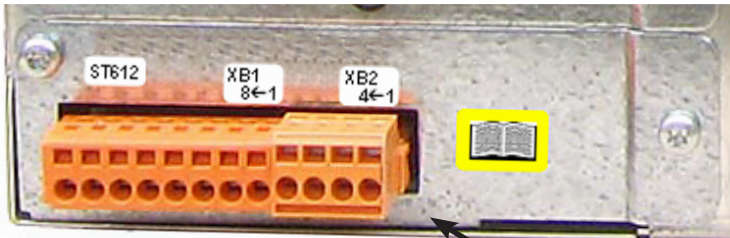

XB 1 XB 2

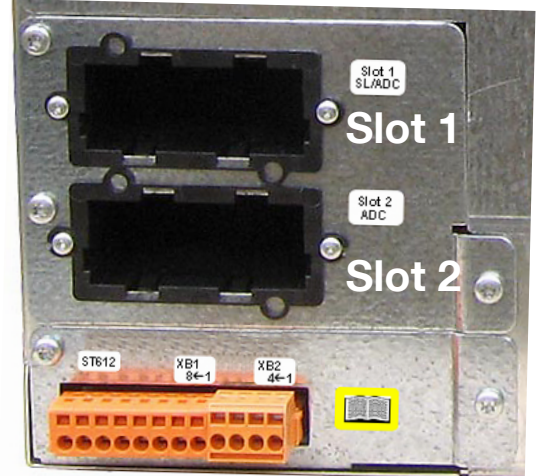

XB 1:

- 1 output for the general alarm, terminal 1 = Normally Open, 2 = Common, 3 = Normally Closed,
- 1 output for the preventive maintenance alarm, 4 = Normally Open, 5 = Common, 6 = Normally Closed,
- 1 input for an emergency stop button (not supplied), terminals 7 and 8, Normally Open (on request Normally Closed)

XB 2:

- 1 output for tripping of upstream protection (source 1), terminals 1 and 2 (see § 7.8.1),
- 1 output for tripping of upstream protection (source 2), terminals 3 and 4 (see § 7.8.1).

STATYS is also equipped with 2 spare slots (slot 1 and slot 2) which can each house one communication module:

- 1 serial port module (JBus/ModBus or Profibus or DeviceNet) on slot 1 only,

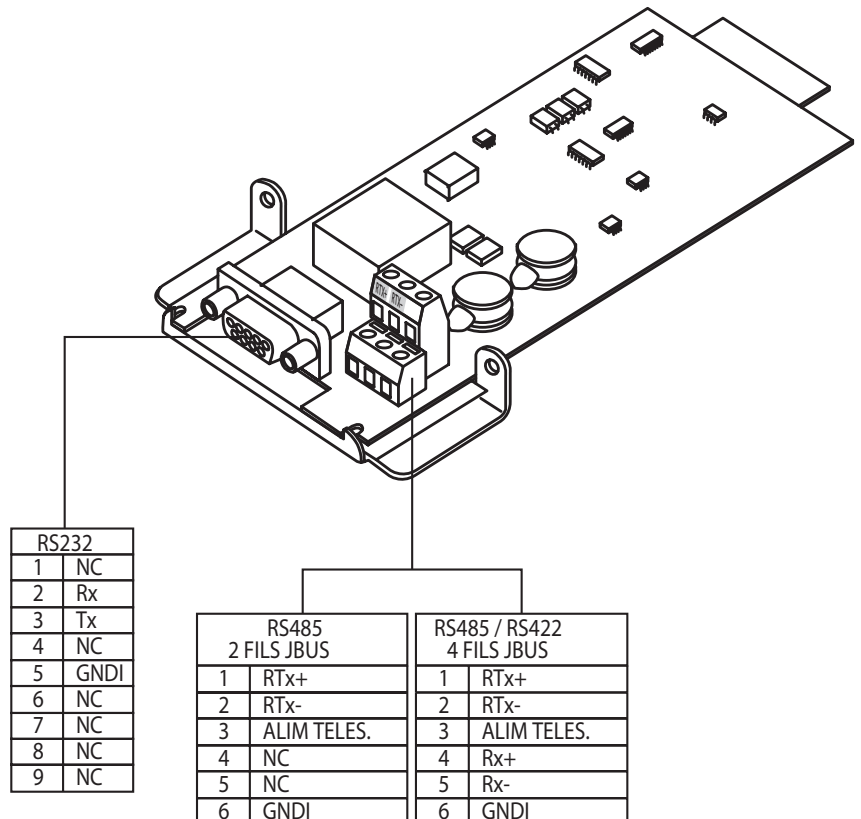

- 1 to 2 alarm relay modules (each module providing 3 inputs and 4 outputs).

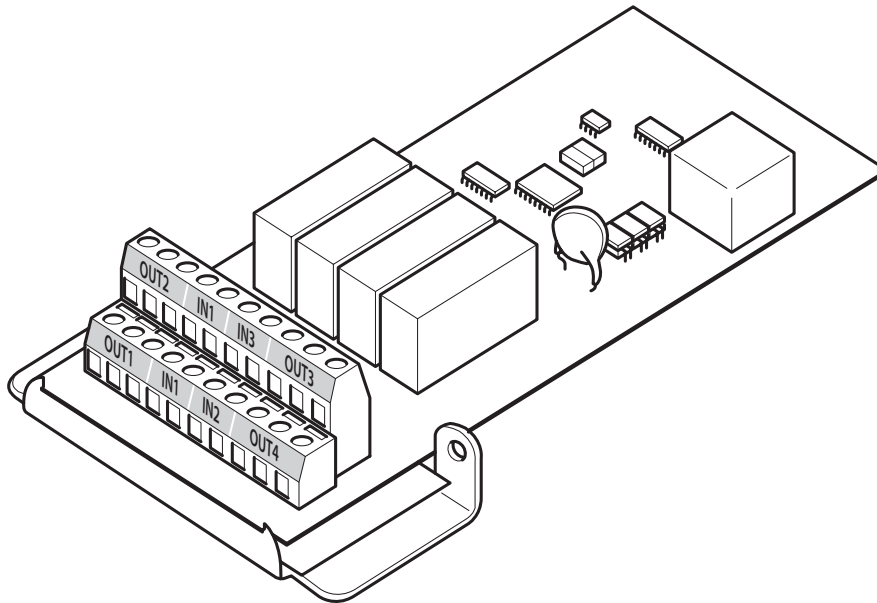

	SLOT 1	SLOT 2	
Relay modules	•	•	* It is possible to use one isolated serial PCB only.
Serial port*	•		

Description of the output alarm according to chosen Com Slot:

Relay	OUT 1	OUT 2	OUT 3	OUT 4
SLOT 1	Load on preferred source	Load on alternate source	Transfer impossible	Auto re-transfer impossible
SLOT 2	Source 1 OK	Source 2 OK	Sources are synchronised	S1 is preferred source

These values can be modified (by a SOCOMEC Service technician) by those one (depending on product):

STS STATUS :

Source 1 OK	Source 1 critical	Source 1 out of tolerance	Source 1 absent
PowerPath 1 OK	Source 2 OK	Source 2 critical	Source 2 out of tolerance
Source 2 absent	PowerPath 2 OK	Srcs perm. Synchronised	Sliding Sources
Srcs perm. Not Synchron.	Srcs Instant. Synchron.	S1 is preferred source	Load on preferred source
Load on auxiliary source	Load not supplied	Load on manual by-pass1	Load on manual by-pass2
Load on S1	Load on S2	Transfer locked ext.	Output OK
Output out of tolerance	Output absent	ESD input active	Q41 closed
Q42 closed	SS1 closed	SS2 closed	Q30 closed
Q51 closed	Q52 closed	Remote controls enabled	Maintenance alert
User mode.			

STS ALARMS:

Imminent stop	Output Isc detection	Manual By-Pass	Overload
Consecutive Detections	Switchback impossible	Transfer impossible	PowerPath1 deteriorated
PowerPath1 short circuit	PowerPath1 in failure	PowerPath2 deteriorated	PowerPath2 short circuit
PowerPath2 in failure	Backfeed1 protection open	Backfeed2 protection open	Ambient temperature max
Insufficient resources	HMI Alarm	Electronics	Custom input alarm
Preventive alarm	General Alarm.		

13. ADVANCED DIAGNOSTICS AND PARAMETERS

STATYS is equipped with a diagnostic plug on the front panel, for connection of a maintenance computer. This link can be used for adjusting the advanced parameters and other settings according to specific operational needs. Maintenance personnel can also use this link to download the event log, statistics and comprehensive information for rapid and complete diagnostics.

14. MAIN FEATURES

14.1. ELECTRICAL CHARACTERISTICS - INPUTS

Rating	63A	100A
Nominal voltages (source 1 / source 2)	208-220V/ 380-415V / 440V	
Nominal voltage tolerance	± 10% of Un (standard setting)	
Rated Frequency	50 or 60 Hz	
Frequency tolerance	± 2.5 Hz (can be configured up to ± 5 Hz)	
Current crest factor	≤3.5	

14.2. ELECTRICAL CHARACTERISTICS - OUTPUT

Rating	63A	100A
Nominal voltages	Same as input voltages	
Rated Frequency	Same as input frequencies	
Current	63A	100A
Current crest factor	≤3.5	
Overloads	See § 8.4	

14.3. MECHANICAL CHARACTERISTICS

Rating	63A	100A
Height	400 mm	
Width	483 mm	
Depth	648 mm	
Weight	58 Kg	
Module	3 + 6	

14.4. ENVIRONMENT

Rating	63A	100A
Operating temperatures	0 to 40 °C	
Storage temperatures	-20 to 70 °C	
Protection degree	IP 30	
Humidity	0 - 95%	
Altitude	< 1000 m without derating	
Cooling	Forced cooling	
Noise level	42 dB(A)	

15. GLOSSARY

STS: Static Transfer System

S1: Source 1 input

S2: Source 2 input

preferred source:

source used as normal power supply to the load, generally set by the operator

alternate source:

source used as an alternative power supply to the load when the priority source fails or exceeds the permitted tolerances or is switched off for maintenance.

16. APPENDICES

15. 1. PLAN: DIAGRAM

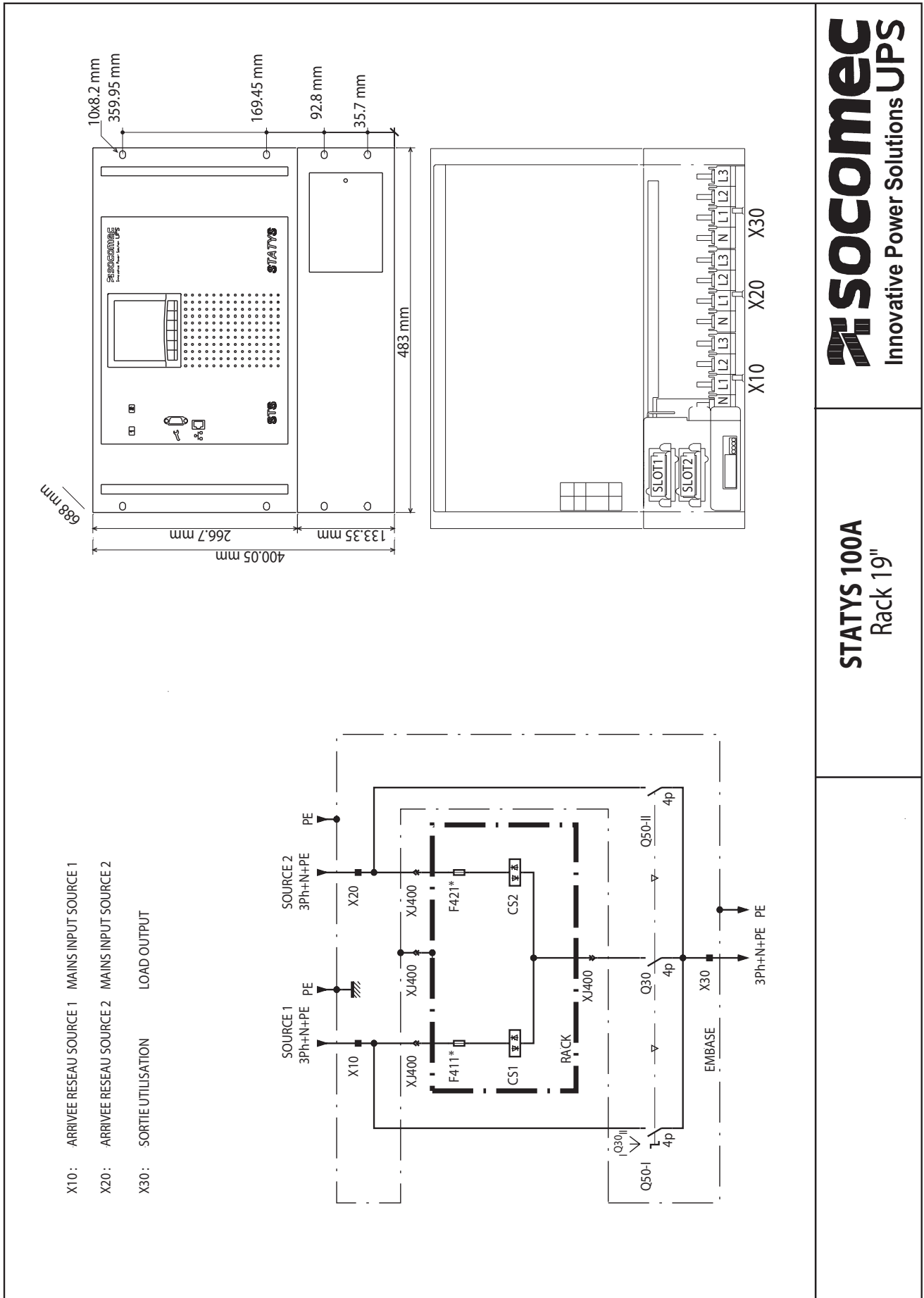

Socomec: our innovations supporting your energy performance

1 independent manufacturer

3,600 employees
worldwide

10 % of sales revenue
dedicated to R&D

400 experts
dedicated to service provision

Your power management expert



POWER
SWITCHING



POWER
MONITORING



POWER
CONVERSION



ENERGY
STORAGE



EXPERT
SERVICES

The specialist for critical applications

- Control, command of LV facilities
- Safety of persons and assets
- Measurement of electrical parameters
- Energy management
- Energy quality
- Energy availability
- Energy storage
- Prevention and repairs
- Measurement and analysis
- Optimisation
- Consultancy, commissioning and training

A worldwide presence

12 production sites

- France (x3)
- Italy (x2)
- Tunisia
- India
- China (x2)
- USA (x3)

28 subsidiaries and commercial locations

- Algeria • Australia • Belgium • China • Canada
- Dubai (United Arab Emirates) • France • Germany
- India • Indonesia • Italy • Ivory Coast • Netherlands
- Poland • Portugal • Romania • Serbia • Singapore
- Slovenia • South Africa • Spain • Switzerland
- Thailand • Tunisia • Turkey • UK • USA

80 countries

where our brand is distributed

HEAD OFFICE

SOCOMEK GROUP

SAS SOCOMEK capital 10 607 040 €
R.C.S. Strasbourg B 548 500 149
B.P. 60010 - 1, rue de Westhouse
F-67235 Benfeld Cedex
Tel. +33 3 88 57 41 41 - Fax +33 3 88 57 78 78
info.scp.isd@socomec.com

www.socomec.com



UK OFFICE

SOCOMEK U.K. Limited

Power Conversion (UPS)
7-9 Lakeside Business Park,
Broadway Lane, South Cerney,
Gloucestershire, GL7 5XL.
Tel. +44 (0) 333 015 3002
info.uk@socomec.com

UK
CA

YOUR DISTRIBUTOR / PARTNER

100 years
OF SHARED ENERGY

socomec
Innovative Power Solutions