

DIRIS A-40

Multifunction measuring unit - PMD

measurement, monitoring and event analysis with smart sensors - door mounting



DIRIS A-40

Function

The **DIRIS A-40** is a panel-mounted power monitoring device (PMD). It is designed for measuring, monitoring and reporting electrical energy.

The DIRIS A-40 offers a range of functions for measuring voltage, current, power, energy and quality. It allows the analysis of a single-phase or three-phase load.

Advantages

Assisted configuration

The configuration wizard guides the user step by step. It also detects and corrects configuration errors. This cuts the commissioning time in half and always delivers a reliable result.

Smart sensors

Three current sensor formats (solid-core TE, split-core TR/ITR and Rogowski coil TF) allow integration of the DIRIS A-40 into new and existing electrical installations.

Connected to the Cloud

The range comprises IoT ready connected products that enable data to be exported automatically for remote operation without any limit on time, distance and time in storage.

Compliant with IEC 61557-12

Reference standard for PMDs (Performance metering & monitoring devices), IEC 61557-12 standard guarantees performance levels and satisfactory performance from the PMDs under the environmental conditions typical of industrial and tertiary applications.

The solution for

- > Industry
- > Building
- > Infrastructure



Strong points

- > Assisted configuration
- > Connected to the Cloud
- > Compliant with IEC 61557-12
- > Smart sensors

Integrated technologies



For more information see our website www.socomec.com

Conformity to standards

- > IEC 61557-12
- > UL E257746
- > EN 50160



Functions

Multi-measurement

- Currents
 - I1, I2, I3, In, Isystem
- Voltages & frequency
 - V1, V2, V3, VN, Vsystem, U12, U23, U31, Usystem, f
- Powers
 - P1, P2, P3, ΣP, Q1, Q2, Q3, ΣQ, S1, S2, S3, ΣS
 - Predictive powers ΣP, ΣQ, ΣS
- Power factor
 - PF1, PF2, PF3, ΣPF
- Cos φ & tangent φ
 - Instantaneous values per phase

Metering

- Active energy: +/- kWh
- Reactive energy: +/- kvarh
- Apparent power: kVAh
- Multi-tariff (8 max.)
- Hour Meter

Quality

- Voltage Unbalance
 - Vdir, Vinv, Vhom, Udir, Uinv, Unba, Vnba, Vnb, Unb
- Current unbalance
 - Idir, linv, Ihom, Inba, Inb
- Total harmonic distortion
 - Currents THDi1, THDi2, THDi3, THDIN, TDDI
 - Phase-to-neutral voltage THDv1, THDv2, THDv3
 - Phase-to-phase voltage THDu12, THDu23, THDu31
- Individual harmonics up to 63rd
 - Currents: HI1, HI2, HI3, HIn
 - Phase-to-neutral voltage: HV1, HV2, HV3
 - Phase-to-phase voltage: HU12, HU23, HU31
- Kfactor & Crest factor
- Events according to EN 50160
 - Voltage dips, outages, interruptions, swells
- Waveform capture
 - Automatic waveform captures when event occurs, and manual recording of the waveform
 - Available through communication

Monitoring of protection

- Auxiliary contact monitoring
- Report and alarm on trips
- Number of operations

Load curves and historical records (max. 130 days)

- Active, reactive and apparent power
- Currents, voltages and frequency

Alarms

- Alarms for all electrical values, events and input status changes, possibility of logical combination
- Time-stamping of events

Communication

- DIRIS A-40 RS485 Modbus as standard
- DIRIS A-40 Ethernet Modbus
- DIRIS A-40 PROFIBUS DPV1

Inputs

- 3 digital inputs
 - Power supplied from DIRIS A-40 or an external source
 - Function: logic status, status of circuit breaker, counting of pulses or synchronization multifund metering
- 2 logical outputs
 - Function: Command, energy pulse output, load shedding, alarm

Functions

Monitoring

- Real-time measurement of electrical values.
- View data as graphs or tables.
- Power quality analysis of the utility supply and of loads.



Metering

- Measurement of active, reactive and apparent energies.
- Historical record of measurements.
- Graphic display on monthly, weekly, daily or hourly basis.



Alarming

- Display of alarms.
- History of alarms.

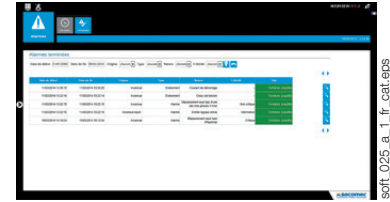

Terminals

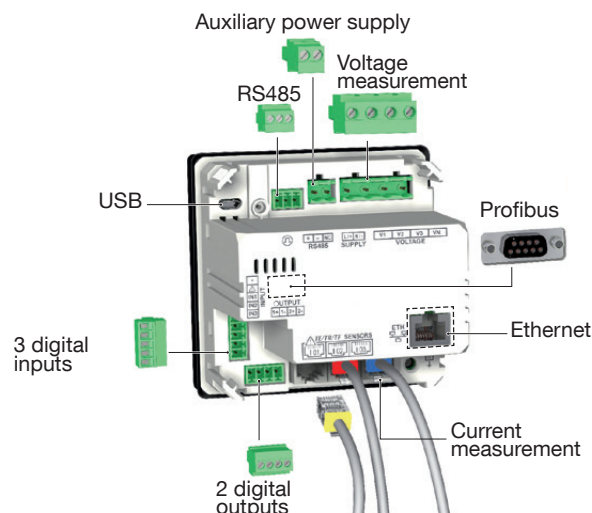

Dimensions (mm)

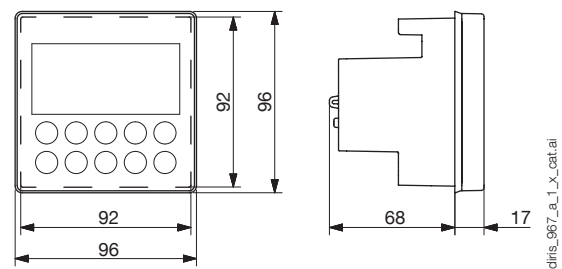

Current measurement

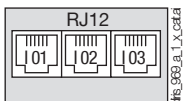

3 inputs supplied by the product

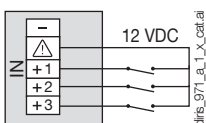

3 inputs with external power supply

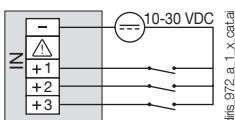

Voltage connections inc auxiliary power supply

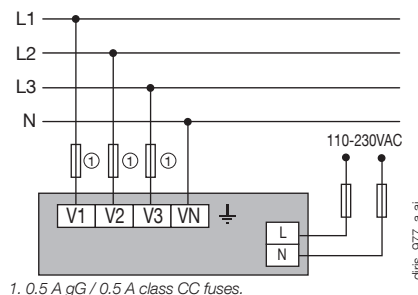

2 outputs

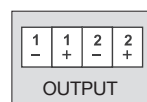

Earth



RS485

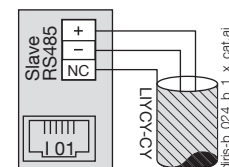

DIRIS A-40

Multifunction measuring unit - PMD

measurement, monitoring and event analysis with smart sensors - door mounting

Connections

Associated current sensors

Various types of current sensors can be connected to the DIRIS A-40: solid-core (TE), split-core (TR/iTR) or Rogowski (TF). This range of sensors is suitable for all types of new or existing installations. A quick RJ12 connection makes wiring easy and reliable and prevents wiring errors. The DIRIS A-40 automatically recognizes the sensor size and type. This guarantees the overall accuracy of the DIRIS A-40 + current sensor measurement chain. For more information: see "TE, TR/iTR, TF sensors" pages.

TE solid current sensors

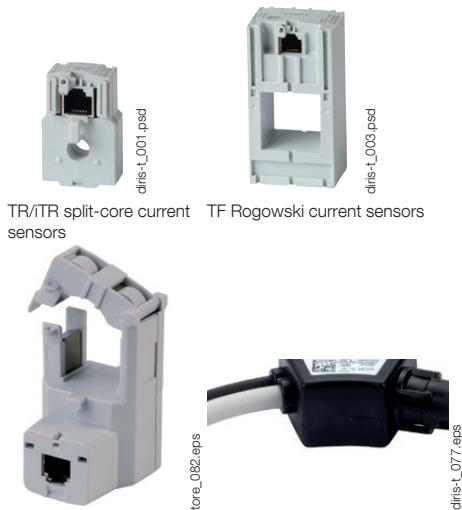

TE / TR/iTR / TF current sensors

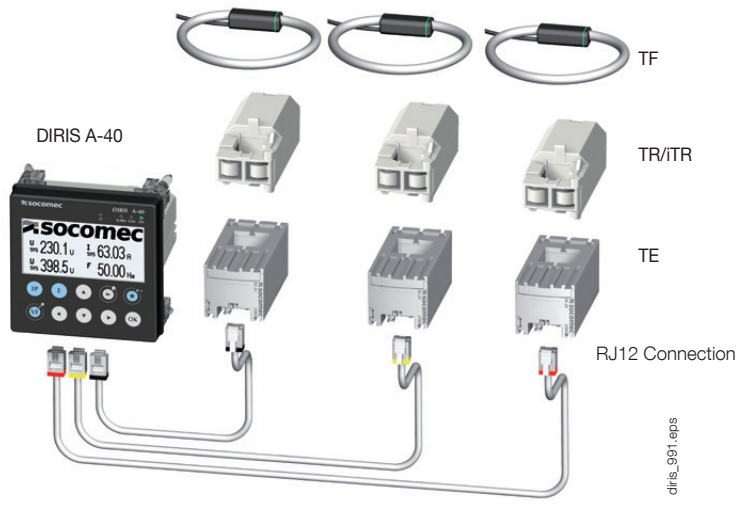

Network and connection examples

Three-phase + Neutral

3P+N - 3 CT (1 three-phase load + calculated Neutral)

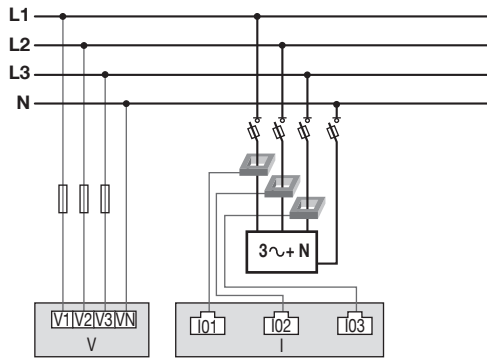

diris_973_a.ai

Three-phase

3P - 3CT (1 three-phase load)

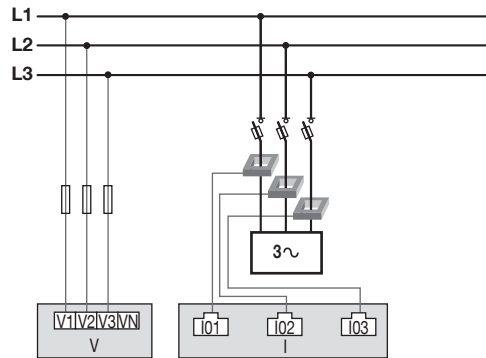

diris_974_a.ai

Three-phase

3P - 1CT (1 balanced three-phase load)

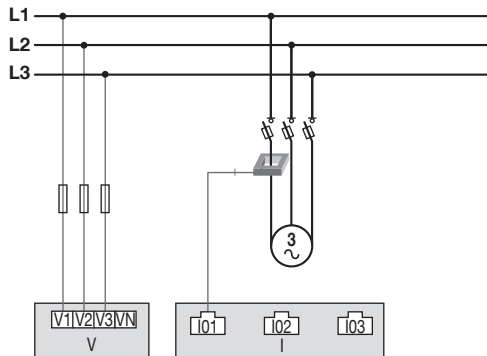

diris_975_a.ai

Single-phase

1P+N - 1CT (1 single-phase load)

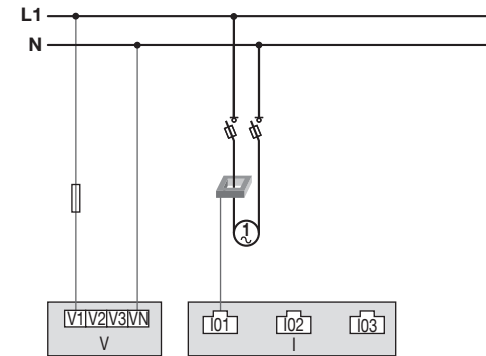

diris_976_a.ai

1. 0.5 A gG / 0.5 A class CC fuses.
If self-supplied, a fuse must always be added to the Neutral.

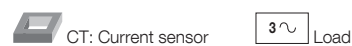

DIRIS A-40 characteristics

Electrical characteristics

Auxiliary power supply	
Alternative voltage	110/400 VAC or 120/300 VDC - Cat III
Frequency	50/60 Hz
Power consumption	5VA AC / 1,5VA DC (48250500) 8VA AC / 2,5VA DC (48250501 & 48250502)
Connection	Removable spring-cage terminal block, 2x 2 positions, 0.5 - 2.5 mm ² solid cable or 0.25 - 1.5 mm ² stranded cable with end piece

Measurement characteristics

Power and energy measurement	
Accuracy	Class 0.2 DIRIS A-40 only
Active energy and active power	Class 0.5 with TE, TF or ITR sensors Class 1 with TR sensors
Accuracy of reactive energy	Class 2 with TE, TR / ITR or TF sensors

Power factor measurement	
Accuracy	Class 0.5 with TE, TF or ITR sensors Class 1 with TR sensors

Voltage measurement	
Characteristics of the network measured	50-300VAC (Ph/N) - 87-520VAC (Ph/Ph) - CAT III
Frequency range	45 to 65Hz
Frequency accuracy	Class 0.02
Network type	Single-phase / Two-phase / Two-phase with neutral / Three-phase / Three-phase with neutral
Measurement by voltage transformer	Primary: 400 000 VAC Secondary: 60, 100, 110, 173, 190 VAC
Input consumption	≤ 0,1 VA
Accuracy of voltage measurement	Class 0.2

Current measurement	
Number of current inputs	3
Associated current sensors	Solid TE, split-core TR / ITR, flexible TF current sensors
Accuracy	0.2 DIRIS A-40 class only Class 0.5 with TE, TF or ITR sensors Class 1 with TR sensors
Connection	Specific Socomec cable with RJ12 connectors

Input characteristics

Number	3
Type / Power supply	Optocoupler with internal (12 VDC ± 10%) or external (12-24 VDC ± 20%) polarisation
Input function	Logic status, status of circuit breaker, synchronization topography, multifluid pulse metering
Connection	Removable screw terminal block, 5 positions, stranded or solid 0.14 - 1.5 mm ² cable

Output characteristics

Number	2
Type	Optocoupler 30 Vd.c. max 20mA max - SELV
Output function	Command, energy pulse output, load shedding, alarm
Connection	Removable screw terminal block, 4 positions, stranded or solid 0.14 - 1.5 mm ² cable

Communication characteristics

DIRIS A-40 RS485	
Link	RS485
Connection type	2 to 3 half duplex wires
Protocol	Modbus RTU
Baud rate	1200 to 115 200 baud
USB	Configuration of DIRIS A-40

References

DIRIS A-40 monitoring devices		Reference
DIRIS A-40	RS485 Modbus - 3 inputs / 2 outputs	4825 0500
DIRIS A-40	Ethernet Modbus TCP or BACnet IP - webserver - RS485 Modbus - 3 inputs / 2 outputs	4825 0501
DIRIS A-40	Profibus DPV1 - RS485 Modbus - 3 inputs / 2 outputs	4825 0502
Accessories		To be ordered in multiples of
Fuse disconnect switches to protect voltage inputs (RM type)		4
Fuse disconnect switches to protect the 1-pole + neutral auxiliary power supply (RM type)		6
gG 10x38 0.5 A fuses		10
		Reference
		5701 0018
		5701 0017
		6012 0000