

ATyS t M

Automatic Transfer Switching Equipment





1. GENERAL SAFETY INSTRUCTIONS	4
2. INTRODUCTION	5
2.1. The ATyS family product range	5
2.2. The ATyS M Range Key Features	6
2.2.1. Selection guide	7
3. QUICK START	8
3.1. Quick Start ATyS t M	8
4. ATYS T M VERSIONS	10
4.1. Product presentation	10
4.2. Specifications and advantages	10
4.3. Supply types	10
5. OPTIONAL ACCESSORIES	11
6. TECHNICAL DATA	12
7. ENVIRONMENTAL CONDITIONS	13
8. PRODUCT INSTALLATION	14
8.1. Changing the padlocking configuration	14
8.2. Recommended orientation	14
8.3. Dimensions	14
8.4. Back plate mounted	14
8.5. DIN rail mounted	15
9. INSTALLATION OF OPTIONAL ACCESSORIES	16
9.1. Auxilliary contacts	16
9.2. Voltage sensing and power supply tap	16
9.3. Bridging bars 4P	17
9.4. Terminal shrouds	17
9.5. Sealable cover	17
10. INSTALLING WITHIN THE ATYS M ENCLOSURE	18
10.1. Polycarbonate enclosure	18
10.1.1. Wiring in a polycarbonate enclosure	18
10.1.2. Extension unit	18
11. CONNECTION OF THE POWER CIRCUITS	19
11.1. Ratings / cross-sections table of correspondence	19
11.2. Parallel pole set-up for a 4P device used in single phase	19
11.3. Network configurations	20
11.3.1. Three phase without neutral network	20
11.3.1.1. Auto-transformer connections	20
12. CONNECTION OF CONTROL/COMMAND CIRCUITS	21
12.1. Terminal connectors designation	22
12.2. Auxilliary contact operating schedule	23

13. OPERATION	.24
13.1. Presentation of the product interface	.24
13.1.1. Product interface	.24
13.1.2. Reset	.24
13.2. Manual mode	.25
13.2.1. Manual switching	.25
13.3. Padlocking	.25
13.4. Programming	.26
13.4.1. Auto-configuration	.26
13.4.2. Sealable configuration cover	.26
13.5. Automatic mode	.27
13.5.1. Sealable Auto/Manual cover	.27
13.6. Possible actions	.27
14. PREVENTATIVE MAINTENANCE	.28
15. TROUBLESHOOTING GUIDE	.29

1. GENERAL SAFETY INSTRUCTIONS

- This manual provides instructions on safety, connections and operation of the ATyS M transfer switch manufactured by SOCOMEC.
- Whether the ATyS is sold as a loose product, as a spare, as an enclosed solution or as any other configuration, this device must always be installed and commissioned by qualified and experienced personnel, in line with the manufacturers recommendations, following good engineering practices and after having read and understood the details in the latest release of the relative product instruction manual.
- Maintenance on the product and any other associated equipment including but not limited to servicing operations must be performed by adequately trained and qualified personnel.
- Each product is shipped with a label or other form of marking including rating and other important specific product information. One must also refer to and respect markings on the product prior to installation and commissioning for values and limits specific to that product.
- Using the product outside the intended scope, outside SOCOMEC recommendations or outside the specified ratings and limits can cause personal injury and/or damage to equipment.
- This instruction manual must be made accessible so as to be easily available to anyone who may need to read it in relation with the ATyS.
- The ATyS meets the European Directives governing this type of product and includes CE marking on each product.
- No covers other than that for auto/manu on the ATyS should be opened (with or without voltage) as there may still be dangerous voltages inside the product such as those from external circuits.
- **Do not handle any control or power cables connected to the ATyS when voltage may be present on the product directly through the mains or indirectly through external circuits.**
- Voltages associated with this product may cause injury, electric shock, burns or death. Prior to carry out any maintenance or other work on live parts or other parts in the vicinity of exposed live parts, ensure that the switch including all control and associated circuits are de-energized.

 DANGER	 WARNING	 CAUTION
RISK: Electric shock, burns, death	RISK: Possible personal injury	RISK: Equipment damage

- As a minimum the ATyS M comply with the following international standards:
 - IEC 60947-6-1
 - GB 14048-11
 - EN 60947-6-1
 - VDE 0660-107
 - BS EN 60947-6-1
 - NBN EN 60947-6-1
 - IEC 60947-3
 - IS 13947-3
 - EN 60947-3
 - NBN EN 60947-3
 - BS EN 60947-3

The information provided in this instruction manual is subject to change without notice, remains for general information only and is non-contractual.

2. INTRODUCTION

ATyS t M “Automatic Transfer Switching Equipment” (ATSE) is designed for use in power systems for the safe transfer of a load supply between a normal and an alternate source. The changeover is done in open transition and with minimum supply interruption during transfer ensuring full compliance with IEC 60947-6-1, GB 14048-11 and other international TSE standards as listed.

The ATyS t M is a full load break (switch type) derived transfer switching equipment where the main components are proven technology devices also fulfilling requirements in IEC 60947-3 standards.



As a Class PC ATSE, the ATyS t M is capable of “making and withstanding short circuit currents” assigned to IEC 60947-3 utilization categories of up to AC23A, GB 14048-11, IEC 60947-6-1 and equivalent standards with utilization categories of up to AC33B.

ATyS t M transfer switches ensure:

- Power Control and Safety between a normal and an alternate source.
- A complete product delivered as a fully assembled and tested solution.
- Intuitive HMI for emergency / local operation.
- Integrated and robust switch disconnection.
- Window with clearly visible position indication I – 0 - II.
- An inherent failsafe mechanical interlock.
- Stable positions (I – 0 – II) non affected by typical vibration and shocks.
- Constant pressure on the contacts non affected by network voltage.
- Energy Efficient with virtually no consumption whilst on the normal, alternate or off positions.
- Extremely rugged, error free and built in padlocking facility (configurable).
- Straight forward installation with effective ergonomics.
- Simple motorization control interface.
- ATS configuration through 4 potentiometers and DIP switches.
- Auxilliary contacts for switch positions I – 0 - II (optional).
- “Product availability” output.
- Ample accessories to suit specific requirements.
- Fully integrated ATS controller specifically designed for Mains / Mains and Mains / Genset applications.

2.1. The ATyS family product range

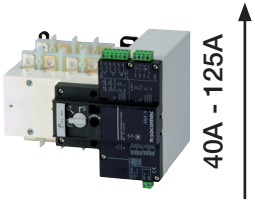
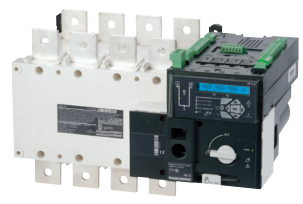
Just the right ATyS for your application...

ATyS: Small Footprint		ATyS M: Modular Profile	
<p>Back to Back Configuration</p>  <p>40A - 125A</p> <p>ATyS d S Small Genset with DPS</p> <p>ATyS S (RTSE) Small Gense</p>	 <p>125A - 3200A</p> <p>ATyS p Power / Genset Management</p> <p>ATyS g Simple Genset Management</p> <p>ATyS t Transformer Management</p> <p>ATyS d RTSE (DPS)</p>	 <p>40A - 160A</p> <p>ATyS p M Evolved Genset Management</p> <p>ATyS g M Simple Genset Management</p> <p>ATyS t M Transformer (building) Management</p>	<p>ATyS d M RTSE (DPS)</p> <p>Side by Side Configuration</p>
	<p>ATyS r RTSE</p> <p>⁽¹⁾ATyS  RTSE</p>		

⁽¹⁾ The UL version of ATyS r is available from 100 - 400A

2.2. The ATyS M Range Key Features

Selecting the right ATyS M will depend on the application, the functionality required as well as the nature of the installation in which the ATyS M will be installed. Below is an outline product selection chart listing the key features of each product to help you select the right ATyS M for your needs.

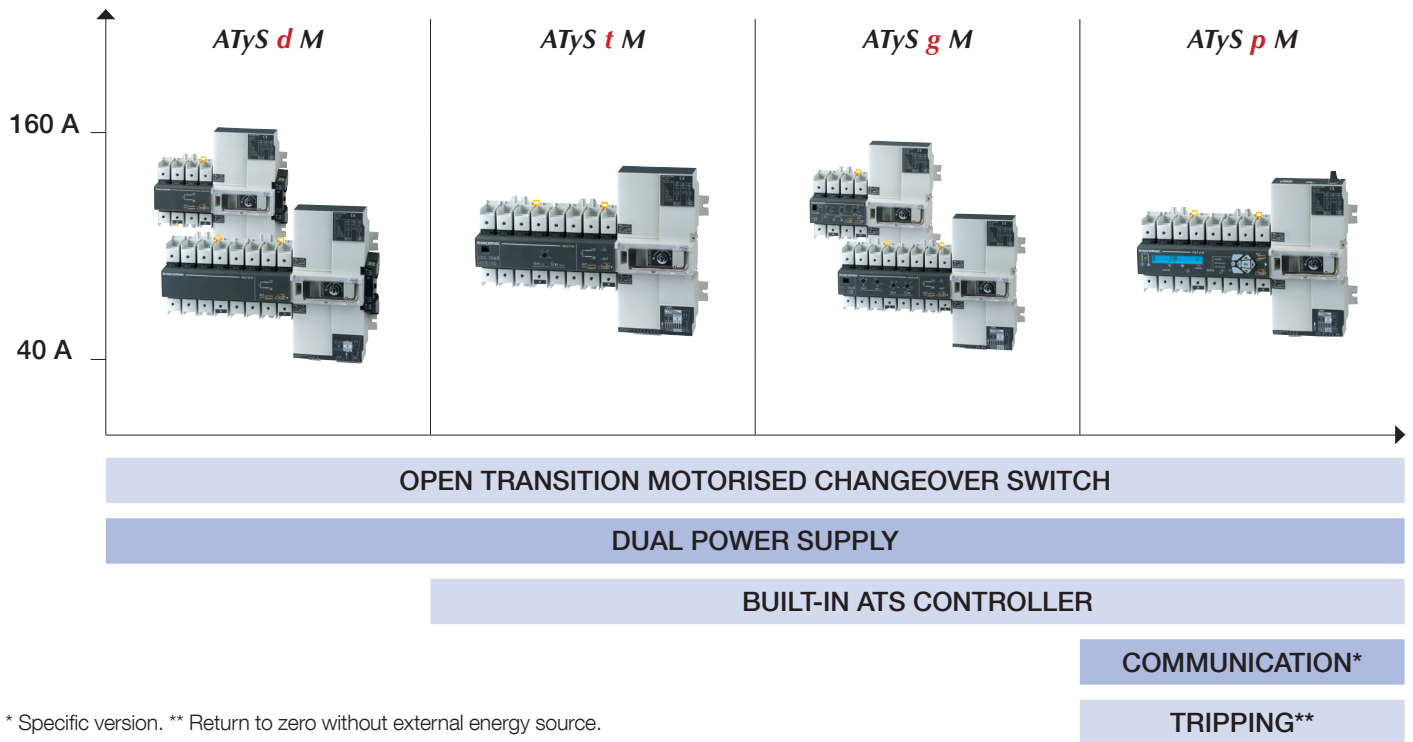

* Specific version. ** Return to zero without external energy source.

A product for virtually all power changeover applications from 40 to 160 A

- ▶ Network/Genset
- ▶ Genset/Genset
- ▶ Network/Network

Applications with an External ATS Control

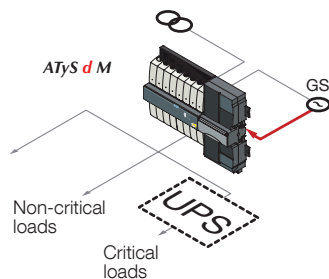

- ▶ Network/Network
- Building applications

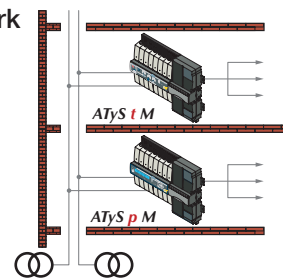

- ▶ Network/Genset
- Genset Applications for Standby Power

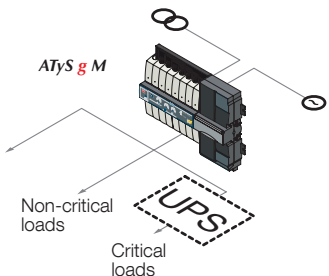

- ▶ Network/Genset
- ▶ Network/Network

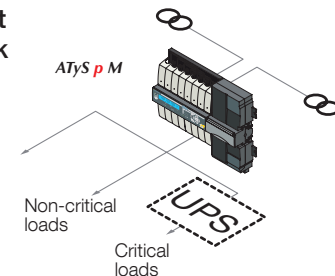

2.2.1. Selection guide

Six ratings 40/63/80/100/125/160 A

	<i>ATyS d M</i>	<i>ATyS t M</i>	<i>ATyS g M</i>	<i>ATyS p M</i>
APPLICATIONS				
Normal/Backup without automatic controller	•			
Normal/Backup with built-in automatic controller		•	•	•
Stable positions	•	•	•	•
Load changeover	•			
FUNCTIONS				
POWER SUPPLY				
External	•			
Integrated		•	•	•
OPERATION				
Backup manual operation of the 3 positions	•	•	•	•
Electrical (dry contact) control of positions I, 0 and II	•			•*
Automatic control of positions I, 0 and II		•	•	•
Return to 0 position feature upon loss of source				•
MONITORING				
3 voltages on networks I and II		•	•	•
Frequency on networks I and II		•	•	•
Phase rotation on networks I and II				•
Asymmetry of networks I and II				•
AUTOMATIC CONTROLLER CONFIGURATION				
By potentiometer and micro-switch		•	•	
By screen + keyboard				•
V _n , F _n , V threshold, F threshold		•	•	•
Driving with or without priority		•	•	•
Adjustable operating timers		•	•	•
Preset configuration				
Control type (impulse or switch/contactor)	•			
DISPLAY				
Position, fully visualised breaking	•	•	•	•
LED: source status, automatic mode, fault LED		•	•	•
LED: switch positions, supply, tests, control				•
V, F, timers, number of operations, last event				•
REMOTE CONTROL				
Outputs				
Generator start/ stop order			•	•
Product availability (not fault and not manual mode)			•	•*
Source available		•		•*
Programmable output (source, availability, fault)				•*
Inputs				
Test on load			•	•*
Retransfer			•	•*
Automatic mode inhibit		•	•	•*
Position O order		•		•*
Priority		•	•	•
Other programmable inputs (test off-load, position control, etc.)				•*
Remote control				
Human/Machine Interface (D10 and D20)				•
RS485 communication (MODBUS)				•**

* 3 inputs/3 outputs (programmable).

** Product reference is different: communication by RS485 connection (MODBUS) allows up to 31 ATyS M to be connected to a PC or a PLC over 1500 m.

3. QUICK START

3.1. Quick Start ATyS t M



QUICK START EN 40 - 160A (4P)

ATyS t M

Automatic Transfer Switching Equipment

Preliminary operations

Check the following upon delivery and after removal of the packaging:

- Packaging and contents are in good condition.
- The product reference corresponds to the order.
- Contents should include:
 - Qty 1 x ATyS M
 - Qty 1 x Emergency handle extension rod
 - Qty 1 x Set of terminals
 - Quick Start instruction sheet

Warning

⚠ Risk of electrocution, burns or injury to persons and / or damage to equipment.

This Quick Start is intended for personnel trained in the installation and commissioning of this product. For further details refer to the product instruction manual available on the SOCOMECS website.

- This product must always be installed and commissioned by qualified and approved personnel.
- Maintenance and servicing operations should be performed by trained and authorised personnel.
- Do not handle any control or power cables connected to the product when voltage may be, or may become present on the product, directly through the mains or indirectly through external circuits.
- Always use an appropriate voltage detection device to confirm the absence of voltage.
- Ensure that no metal objects are allowed to fall in the cabinet (risk of electrical arcing).

Failure to observe good engineering practises as well as to follow these safety instructions may expose the user and others to serious injury or death.

⚠ Risk of damaging the device

- In case the product is dropped or damaged in any way it is recommended to replace the complete product.

Accessories

- Bridging bars 125A or 160A.
- Control voltage transformer (400Vac -> 230Vac).
- Voltage sensing and power supply tap.
- Terminal shrouds.
- Auxiliary contact blocks.
- Polycarbonate enclosure.
- Polycarbonate extension box.
- Power Connection Terminals.
- Sealable cover.



www.socomec.com
www.socomec.com/operating-instructions
To download, brochures, catalogues and technical manuals.

Printing informations: 1 color Black. White paper 90g/m².
Printing size: 420x297. Final size 210x297. This page visible first.
A separate sheet for each language.

CORPORATE HQ CONTACT:
SOCOMECS SAS, 1-4 RUE DE WESTHOUSE, 67235 BENFELD, FRANCE



Non contractual document.
Subject to change without notice.

Installation and Commissioning

STEP 1
Cabinet / Back Plate Installation

STEP 2
Connecting the POWER section

STEP 3
CONTROL / AUX POWER terminal connections

STEP 4
CHECK

STEP 5
Programming

STEP 6A
Automatic Operation

STEP 6B
Emergency Manual Operation

STEP 6C
Padlocking

STEP 6A Automatic operation

Close the front cover as shown to put the product into automatic mode.

STEP 6B Manual operation

- Open the front cover as shown to put into manual mode.
- Use the handle situated in the front panel under the cover to operate the transfer switch.
- Check the changeover switch position on the indicator before operating.

STEP 6C Padlocking mode

- In order to padlock put the product in manual mode.
- Pull the locking mechanism and insert a padlock as shown.
- As standard padlocking in the 0 position. Configurable to I-0-II (see step 1).

STEP 4 Check

Whilst in manual mode, check the wiring and if ok power up the product.

STEP 5 Programming

■ Auto conf. of the network voltage and frequency.

Setting mode A-B

- A: Ready
- B: Auto Conf (Auto-configuration)

- Put dipswitch A-B to position B. (All Led's should be blinking).
- When the LED's become a steady light ON, configuration of the network is ready.
- Put dipswitch A-B back to A.

■ Set dip switches C-D, E-F, G-H

Thresholds C-D

- C: ΔU 10%/ΔF 5%
- D: ΔU 20%/ΔF 10%

HYST: 20 % of ΔU/F settings

Stop in 0 position E-F

- E: No stop in 0 position
- F: 2s stop in 0 position

Priority G-H

- G: With priority
- H: Without priority

STEP 1

Installation

Caution: Ensure that the product is installed on a flat rigid surface.

Recommended orientation

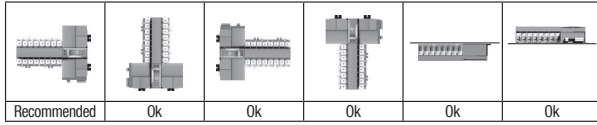

DIN RAIL
IEC 60715

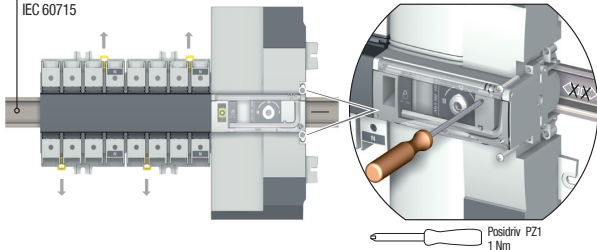

Tighten to avoid movement on the DIN rail.

Posidriv PZ1
1 Nm

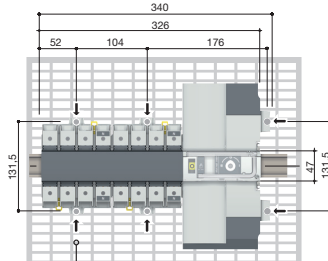
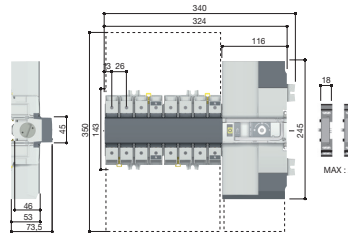

6 mounting brackets
6x M6 screw - 2,5 Nm

Padlocking configuration

The ATyS t M is delivered with padlocking configured to the 0 position.

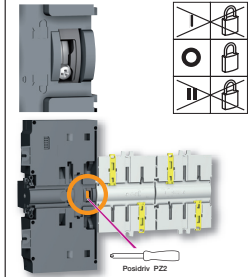

To allow padlocking in all positions (I - 0 - II), configure the ATyS t M as follows before installation. (Screw is located at the back of the product).

STEP 2

Power Terminal Connections

It is essential to tighten all used terminals, with cables and/or bridging bars, before use.



Source supply side

Load side
bridging bar.
125A: 1309 4006
160A: 1309 4016

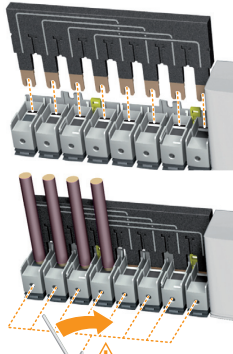

Hexagonal Metric
Allen Size 4
5,0 Nm

10 to
70 mm²
15mm

Voltage taps provide 2x ≤ 1.5mm² connections. They can be fitted in any terminals on the source supply side. Do not use on the load side when equipped with a bridging bar.

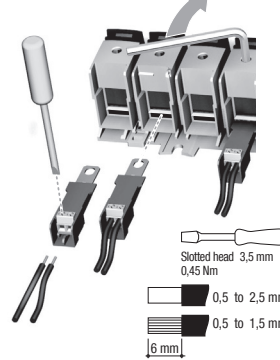

Slotted head 3,5 mm
0,45 Nm

0,5 to 2,5 mm²
0,5 to 1,5 mm²
6 mm

Step 1

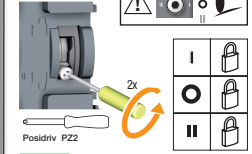

Step 2

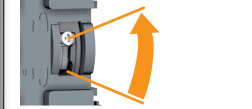

Step 3

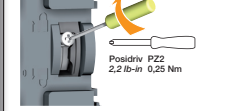

NTROL / AUX POWER Terminals and wiring

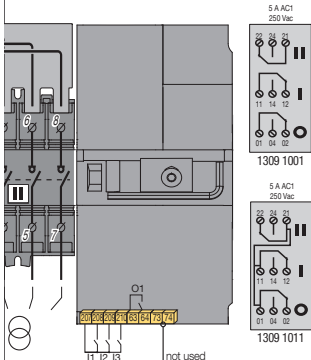

Type	Terminal no.	Description	Characteristics	Recommended connection cross-section
Inputs	207	Common	Dry potential free contact	0,5 to 2,5 mm ² (rigid) 0,5 to 1,5 mm ² (stranded)
	208	Position 0 order		
	209	Open S1 priority. Closed S2 priority.		
Outputs	63/64	Open: S1 and S2 NOT available. Closed: S1 or S2 available	Resistive load 2A 30 Vdc 0.5A 230Vac Pmax: 60W or 125VA Umax: 30Vdc or 230Vac	
	73/74	Not used		
Auxiliary contacts unit.	11/12/14	Position I	Dry potential free contact 250Vac 5A AC1 24Vdc 2A	
	21/22/24	Position II		
	01/02/04	Position 0		

Ensure that the product is in Manual Mode (front cover open).

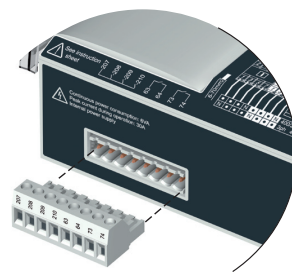

0,5 to 2,5 mm²

0,5 to 1,5 mm²

6 mm

Slotted head 3mm 0,5 Nm

See instruction sheet

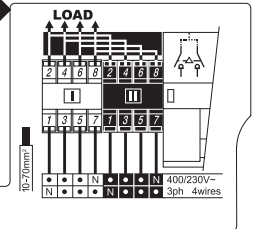

Set potentiometer for priority supply "Failure and Return Timer"
FT: 0-30 sec / RT: 0-30 min.



Source availability LED's

Source	LED ON	LED OFF	LED blinking
Source 1 available	Source 2 available	Source 1 not available	- a timer is counting down
Source 2 available	Source 2 not available	Source 2 not available	- a timer is counting down

Auxiliary contacts: Fitting of auxiliary contacts: 1309 1001 or 1309 1011
To fit an AC, the switch must first be put in position 0. An auxiliary contact module comprises: one NO/NC changeover contact for each position (I-0-II). To install use the long screws supplied with the module.

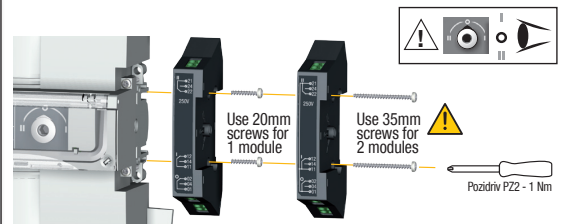

4. ATYS t M VERSIONS

The ATyS t M is available as 4P with the possibility of being used on virtually any automatic open transition type of application.

Measurement accuracy: Frequency: 1 % - Voltage: 1 %

4.1. Product presentation

This quick-acting transfer switch incorporates:

1. 2 mechanically interlocked switches.
2. A quick-acting electric control unit enabling automatic or manual system operation.
3. Electrical specifications compliant with product standards, and a version identification.
4. Changeover switch wiring identification.
5. Connection of control/command circuits.



CAUTION ! Ensure that the load is connected to the top of the switch with the motorisation on the right hand side as shown.

4.2. Specifications and advantages







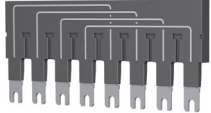

- 1 - Power section:
A fully integrated and interlocked transfer switch, with high electrical performance offering microprocessor control and monitoring.
- 2 - Operation:
A flexible operating mechanism enabling quick motorised transfer in automatic mode or locally in manual mode for emergency operations. Features a locking device to ensure (in position zero) a secured isolation of the load (padlocked).

4.3. Supply types

The power supply of ATyS t M is required to be 220 VAC -20% to 240VAC +20% at a frequency of 50/60 Hz and has been developed so as to meet most network configurations.

	Version 230 / 400 VAC	
	Umin	Umax
Ph-N	176	288
Ph-Ph	305	498

5. OPTIONAL ACCESSORIES

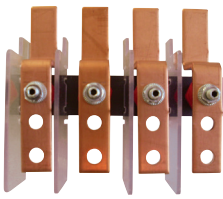
<p>Auxiliary contacts</p>	<p>Each product can take up to 2 auxiliary contact blocks. Each accessory integrates 1 NOC auxiliary contact (for each position I, O and II) 1309 1001 or NONC for 1309 1011. Characteristics: 250 VAC / 5 A maximum. The ATyS d M includes 1x aux contact reference 1309 1001 as standard.</p>		<p>Ref. : 1309 1001 Ref. : 1309 1011</p>
<p>Bridging bars</p>	<p>To provide a common point on the outgoing side of the switch (load side).</p>		<p>Three phase product: Rating ≤ 125A: 1309 4006 Rating 160A: 1309 4016</p>
<p>Voltage sensing and power supply tap</p>	<p>It allows connection of 2 x 1.5 mm² voltage sensing or power cables. The single-pole voltage sensing tap can be mounted in the terminals without reducing their connecting capacity. Do not use with the bridging bar.</p>		<p>Ref. : 1399 4006 2 parts/ref.</p>
<p>Terminal shrouds</p>	<p>Protection against direct contact with terminals or connecting parts. Other features: Perforations allowing remote thermographic inspection without removal. Possibility of sealing.</p>		<p>Ref. : 2294 4016 2 parts/ref.</p>
<p>Double power supply - DPS</p>	<p>Allows an ATyS d M to be supplied by two 230 Vac 50/60 Hz networks.</p>		<p>Ref. : 1599 4001</p>
<p>Enclosure</p>	<p>Fully dedicated to ATyS M use, this polycarbonate enclosure provides easy access to a compact, enclosed transfer switch (HxWxD: 385x385x193mm).</p>		<p>Ref. : 1309 9006</p>
<p>Extension unit</p>	<p>Combined with the polycarbonate enclosure, the extension box creates extra space for routing cables with a larger diameter.</p>		<p>Ref. : 1309 9007</p>
<p>Sealable cover.</p>	<p>It prevents access to the configuration panel of the ATyS t M.</p>		<p>Three phases product: Ref. : 1359 0000</p>
<p>Auto-transformer</p>	<p>For use with ATyS M in 400 VAC three-phase applications without a distributed neutral. As the ATyS M has a 230Vac auxiliary power supply requirement. When no neutral connection is available this autotransformer (400/230 VAC, 400 VA) provides the 230 VAC required for the ATyS M to function.</p>		<p>Ref. : 1599 4121</p>
<p>Power connection terminals</p>	<p>The power connection terminals allow conversion of the cage terminals into bolt-on type connection terminals, enabling connection of up to two 35mm² cables or one 70mm² cable. Each power connection terminal is provided with separation screens.</p>		<p>Ref. : 1399 4017 For complete conversion, order 3 times the reference.</p>

6. TECHNICAL DATA

RATINGS		40A	63 A	80 A	100 A	125 A	160 A
Frequencies		50/60 Hz	50/60 Hz	50/60 Hz	50/60 Hz	50/60 Hz	50/60 Hz
Thermal current I _{th} at 40 °C (A)		40	63	80	100	125	160
Thermal current I _{th} at 50 °C (A)		40	63	80	100	110*	125
Thermal current I _{th} at 60 °C (A)		40	50	63	80	100*	125
Thermal current I _{th} at 70 °C (A)		40	40	50	63	80*	100
Rated insulation voltage U _i (V) (Power circuit)		800	800	800	800	800	800
Rated impulse withstand voltage U _{imp} (kV) (power circuit)		6	6	6	6	6	6
Rated insulation voltage U _i (V) (control circuit)		300	300	300	300	300	300
Rated impulse withstand voltage U _{imp} (kV) (control circuit)		4	4	4	4	4	4
Rated operational currents (A) IEC 60947-3 at 415 VAC at 40 °C	AC 21A / 21 B	40/40	63/63	80/80	100/100	125/125	160/160
	AC 22A / 22 B	40/40	63/63	80/80	100/100	125/125	125/160
	AC 23A / 23 B	40/40	63/63	80/80	100/100	125/125	125/160
Rated operational currents (A) IEC 60947-6-1 415Vac at 40 °C	AC 33B / AC32B **AC 33iB	40/40	63/63	80/80	100/100	125/125	125**/160
Fuse protected short-circuit withstand if using gG DIN fuses	Fuse protected short-circuit withstand (kA eff)	50	50	50	50	50	40
	Associated fuses (gG DIN)	40	63	80	100	125	160
Short-circuit capacity	Rated short-term withstand current: I _{cw} 1s (kA eff)	4	4	4	4	4	4
	Rated short-term withstand current: I _{cw} 30ms (kA eff)	10	10	10	10	10	10
Switching time at I _n excluding loss of supply sensing time and excluding any delay timers applicable.	I-II or II-I (ms)	180	180	180	180	180	180
	Duration of "electrical blackout" at U _n (ms)	90	90	90	90	90	90
	I-O / O-I / II-O / O-II (ms)	45	45	45	45	45	45
Consumption	Inrush current(A)	20	20	20	20	20	20
	Consumption in stabilised state (VA)	6	6	6	6	6	6
Mechanical characteristics	Number of changeovers	10000	10000	10000	10000	10000	10000
Connection cross-section (⚠ not compatible with aluminium cables)	Minimum size (Cu mm ²), flexible and rigid	10	10	10	10	10	10
	Maximum size (Cu mm ²), flexible and rigid	70	70	70	70	70	70
Equipment class (According to IEC 60947-6-1)		PC	PC	PC	PC	PC	PC
EMC environment		A	A	A	A	A	A

* Possibility of reaching 125A with bigger connection cross-sections and use of the 160A bridging bar.

** AC 33iB 160A according to GB 14048.11.



This is a class A product. In a domestic environment, this product may cause radio interference in which case the user may be required to take adequate measures.

7. ENVIRONMENTAL CONDITIONS



Humidity

- 80 % humidity without condensation at 55 °C
- 95 % humidity without condensation at 40 °C



Temperature

- -20 +40 °C without de-rating
- 40 °C < t ≤ 70 °C with de-rating (see Technical Characteristics)



Altitude

- Up to 2000m

Correction factors:

	2 000 m < A ≤ 3 000 m	3 000 m < A ≤ 4 000 m
UE	0.95	0.80
Ie	0.85	0.85



Storage

- 1 year maximum
- Maximum storage temperature: +55 °C
- 80 % humidity without condensation at 55 °C



IP rating

- IP41 in the SOCOMEC polycarbonate modular enclosure see page page 18
- IP2x for non-enclosed modular product

Protection class: Class 1

8. PRODUCT INSTALLATION



Prior to installation of the product ensure that the padlocking setting screw (located at the back of the product) is configured as per your requirements.
For locking in Positions I, II and 0, refer to the following procedure.

8.1. Changing the padlocking configuration

To configure the locking in the 3 positions:

STEP1: loosen the screw at the back of the product as shown below.

STEP2: slide the screw upwards.

STEP3: tighten the screw in the top position as shown.

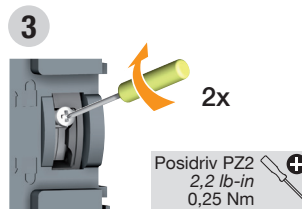
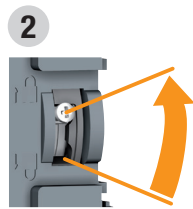
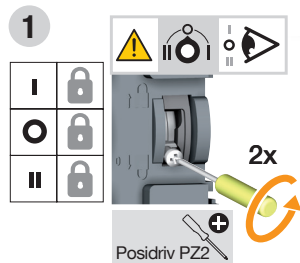
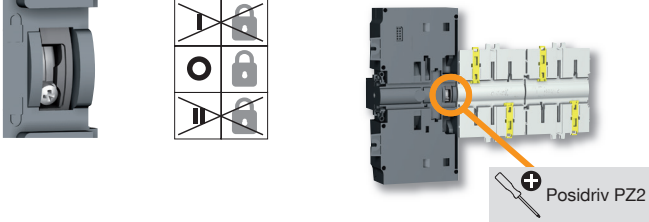

8.2. Recommended orientation

Recommended	Ok	Ok	Ok	Ok	Ok

8.3. Dimensions

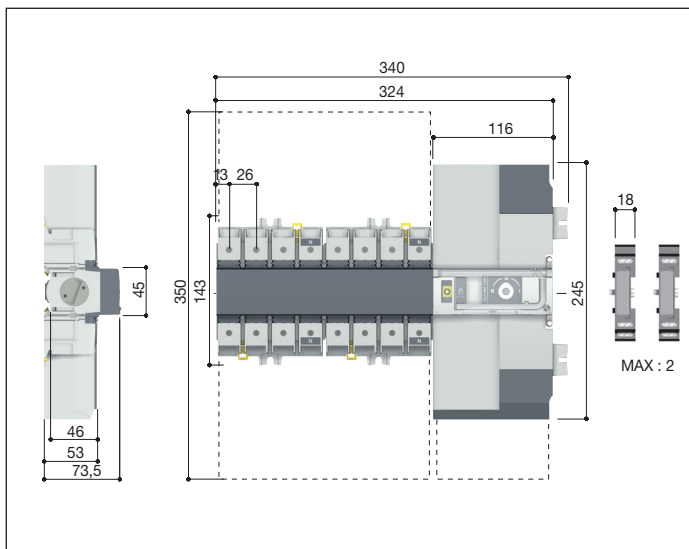

8.4. Back plate mounted

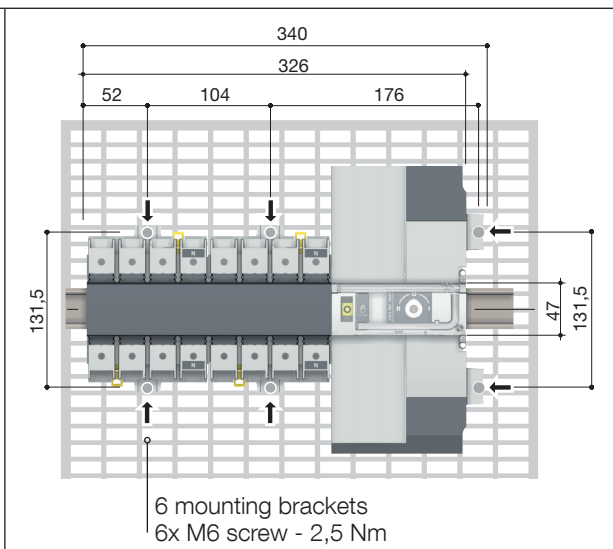

8.5. DIN rail mounted

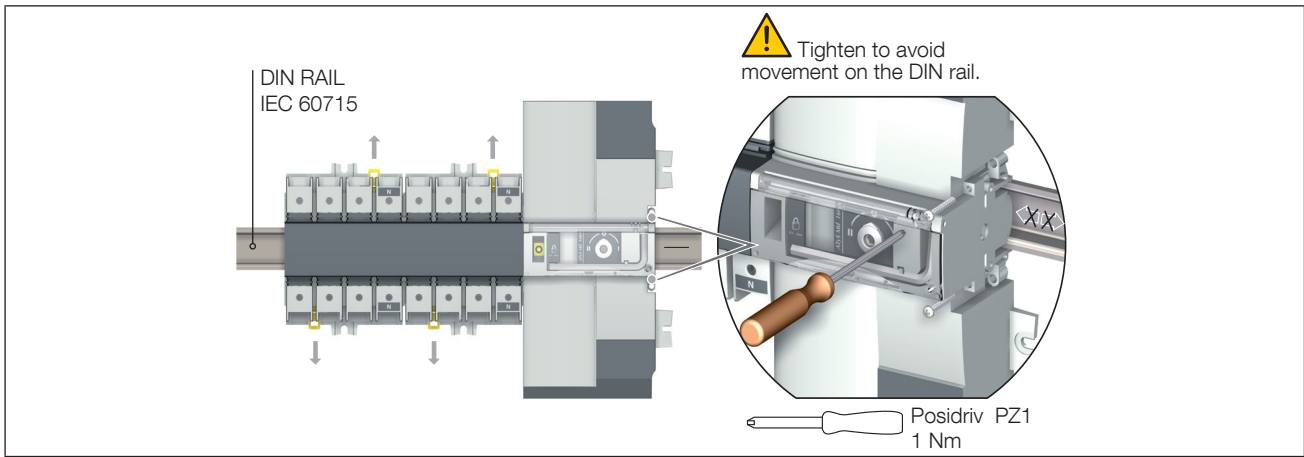

9. INSTALLATION OF OPTIONAL ACCESSORIES

9.1. Auxilliary contacts

Ref. 1309 1001 or ref. 1309 1011.

To fit an additional AC, the switch must first be put in the 0 position. An auxiliary contact module comprises: one NO/NC or NOC changeover contact for each position (I-0-II). To install use the screws supplied with the module. One module is factory fitted.

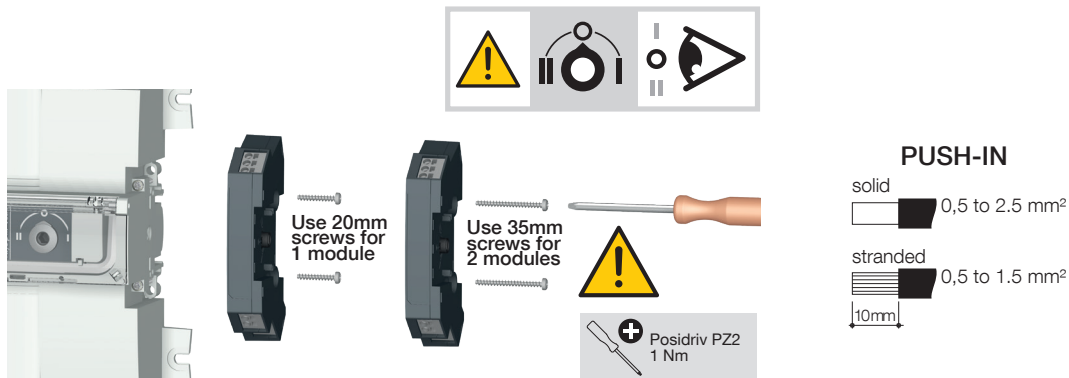

9.2. Voltage sensing and power supply tap

Ref. 1399 4006.

This provides 2 connection terminals for conductors with cross-section $\leq 1.5 \text{ mm}^2$.

The single pole terminals can be fitted in any of the terminal cages without reducing the cage connection capacity. 2 parts/ref. Do not use in case of use of the bridging bar.

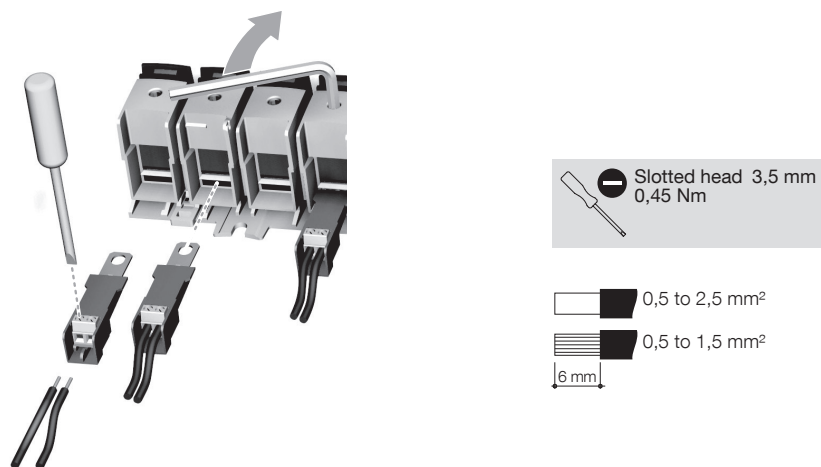

9.3. Bridging bars 4P

Ratings ≤ 125A: ref. 1309 4006; 160A: ref. 1309 4016

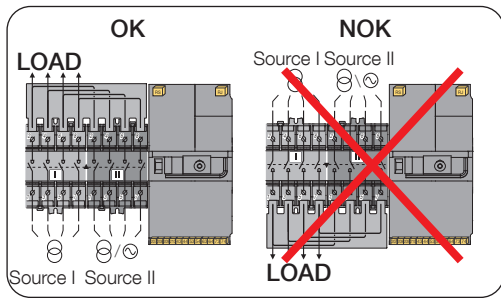

Bridging bar.
125A: 1309 4006
160A: 1309 4016

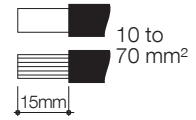
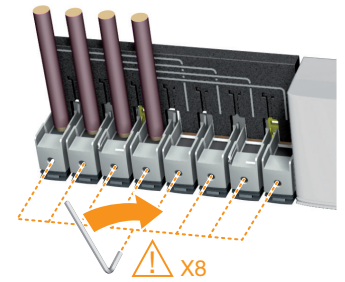
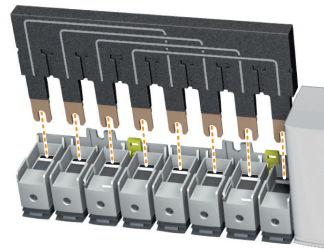

Make sure that the bridging bar is fitted to the correct set of terminals.
There are two references available: one for ratings up to 125A, and another for 160A rating.

9.4. Terminal shrouds

Ref. 2294 4016

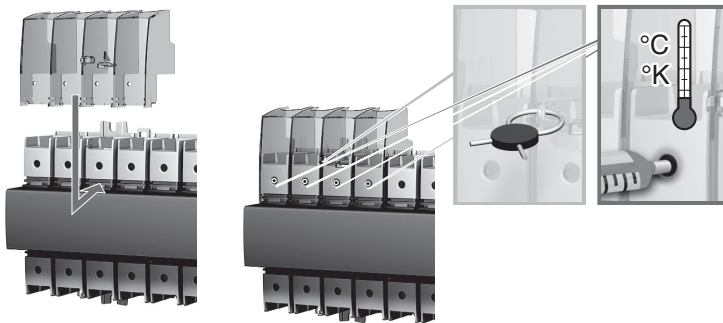

9.5. Sealable cover

Ref. 1359 0000

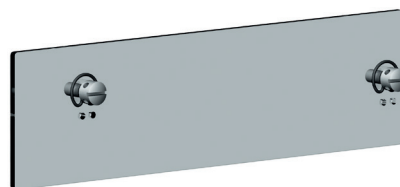
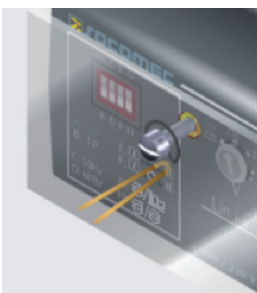

10. INSTALLING WITHIN THE ATYS M ENCLOSURE

10.1. Polycarbonate enclosure

Ref. 1309 9006

Dimensions and mounting

The enclosure must be wall-mounted using screws (not supplied). Recommended size: M6 50 mm (minimum).
Weight : between 8 and 10 kg, depending on the accessories.



Only 1 aux contact block may be installed when using this enclosure.

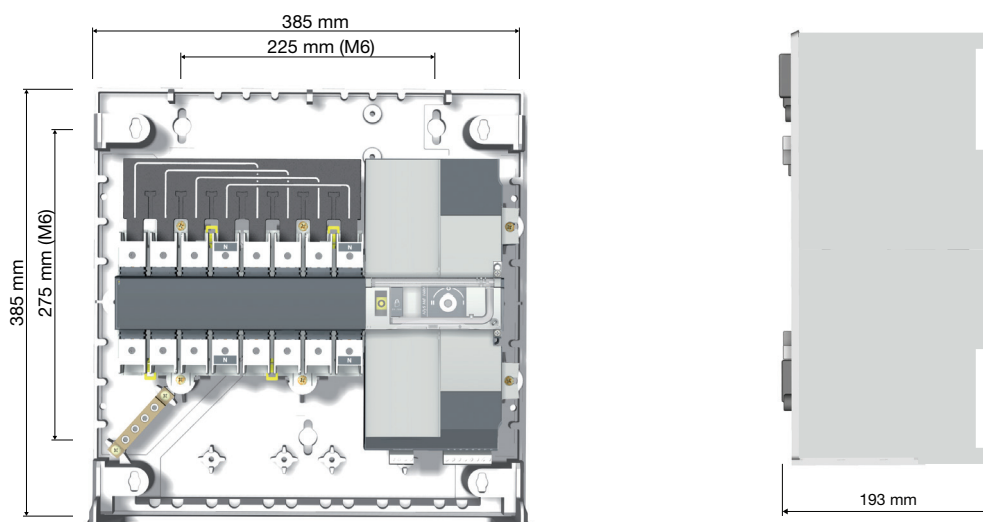

10.1.1. Wiring in a polycarbonate enclosure

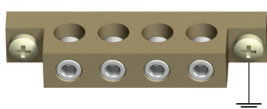

Max cable size 25 mm²



Example: Neutral on the right

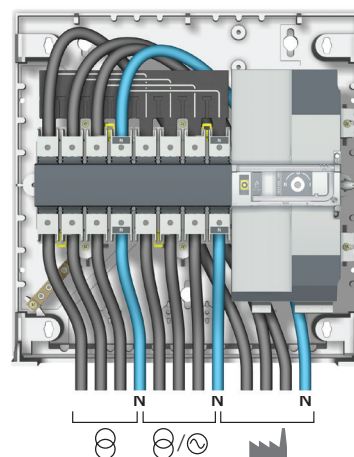

10.1.2. Extension unit

Ref. 1309 9007

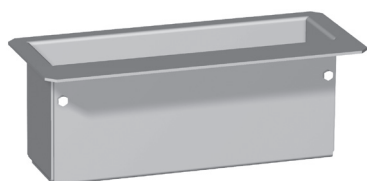

Enables you to allocate additional space to the polycarbonate enclosure (ref. 1309 9006).

11. CONNECTION OF THE POWER CIRCUITS

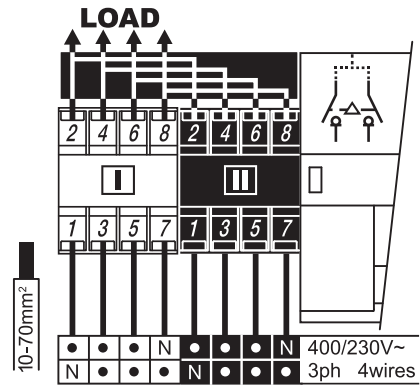
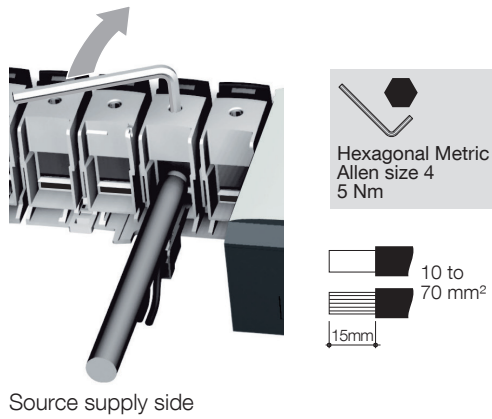

It is essential to tighten all used terminals, with cables and/or bridging bars, before use.

11.1. Ratings / cross-sections table of correspondence

	40 A	63 A	80 A	100 A	125 A	160 A
Min cable size recommended (mm ²)	10	16	25	35	50	50
**Max cable size recommended (mm ²)	50	50	50	50	70*	70*

*With extension unit.

** Maximum cable size for rigid cable is 50 mm². For larger terminations use the power connection terminals ref. 1399 4017.



Not compatible with aluminium cables

11.2. Parallel pole set-up for a 4P device used in single phase

Rating conversion table for use in single phase and two-by-two parallel pole set up.
(Max ambient temperature = 40 °C).

Nominal current rating in three-phase (A)	Nominal current rating in single-phase (2 poles in //) (A)
40	63
63	100
80	125
100	160
125	200
160	250

11.3. Network configurations

Configuration of the network is done through the ATyS t M autoconfiguration feature. Refer to section «13.4. Programming», page 26.

11.3.1. Three phase without neutral network

For three-phase networks without neutral (3NBL) 400Vac, a neutral must be recreated to allow the ATyS M to operate at 230Vac. To recreate the neutral, we recommend the use of quantity 2x 400VA auto-transformers connected as shown below. The neutral position must be defined as neutral on the left or neutral on the right in advance and then wired accordingly. The example below shows the wiring for a product configured with neutral on the left



A new product must have the neutral configuration pre-programmed as on the left or on the right at the first start up using a real (not a recreated) 3 phase + neutral supply.

11.3.1.1. Auto-transformer connections

Reference 1599 4121

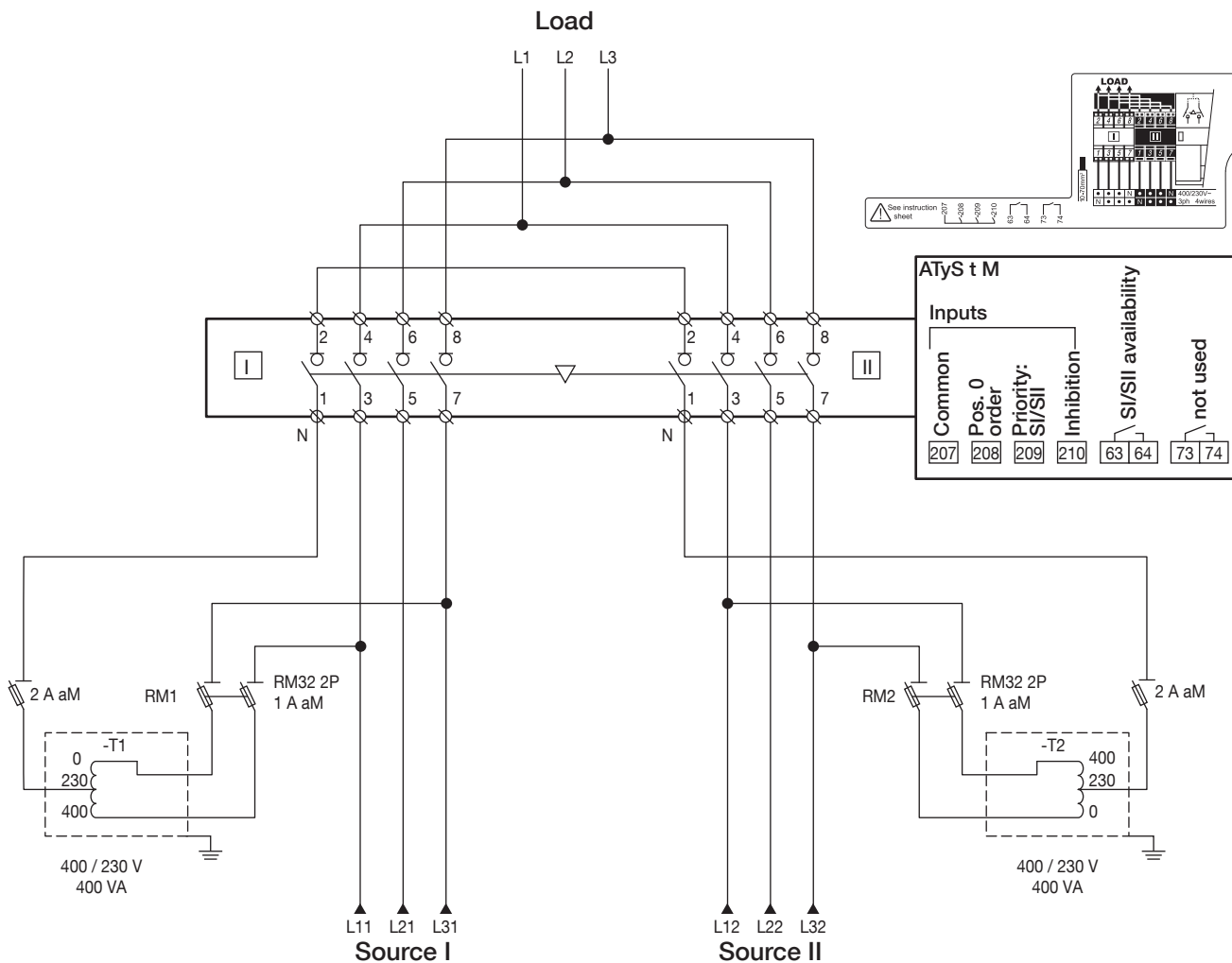

12. CONNECTION OF CONTROL/COMMAND CIRCUITS



Switch to manual mode before connecting the product. (Front Auto/Manu cover open). The product is delivered in the 0 position.

LOAD SIDE

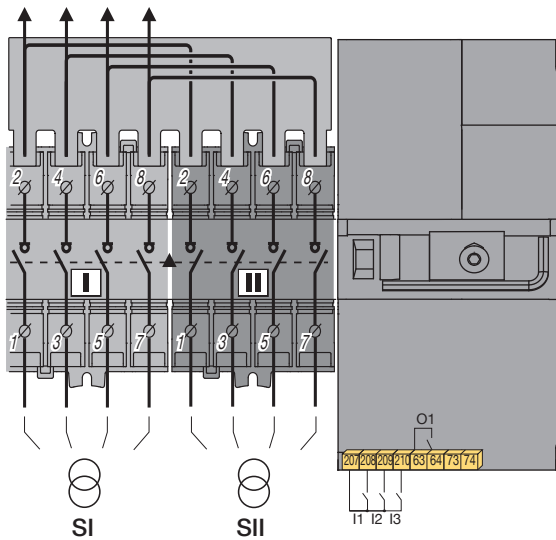

Slotted head 3,5 mm 0,45 Nm

0,5 to 2,5 mm²

0,5 to 1,5 mm²

6 mm

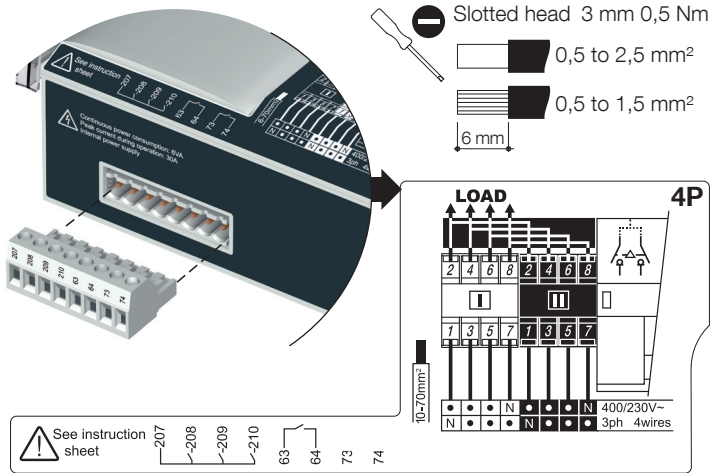
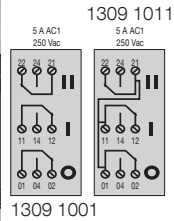

Slotted head 3 mm 0,5 Nm

0,5 to 2,5 mm²

0,5 to 1,5 mm²

6 mm



All pressure on the connector pins is to be avoided during wiring of the auxiliary cables.



The product is delivered in the 0 position and in auto mode. Maximum control cables length = 10 m. In case of longer distance, use control relays.

Source must always be connected as show above.



Ensure that the product is in Manual Mode (front cover open).

12.1. Terminal connectors designation

TYPE	TERMINAL NO.	DESCRIPTION	CHARACTERISTICS	RECOMMENDED CONNECTION CROSS-SECTION
Inputs	207	Common	Do not connect to any power supply	0,5 to 2,5 mm ² (rigid) 0,5 to 1,5mm ² (stranded)
	208*	Position 0 order		
	209	Open S1 priority. Closed S2 priority.		
	210	Inhibition ATS		
Outputs	63/64	Open: S1 and S2 NOT available. Closed: S1 or S2 available	Resistive load 2A 30Vdc 0.5A 230Vac Pmax: 60W or 125VA Umax: 30Vdc or 230Vac	
	73/74	Not used		

Note:

* When input 207 / 208 is closed, the product switches immediately to the position zero (electrical security). Moreover, the product goes into fault mode, and all the automatism is stopped. This function is possible only if the opposite source is available:

- position 1 / source 2 available,
- position 2 / source 1 available.

To restart the automatism you need to open the contact and to have an action to erase the fault (manual mode, inhibition mode, priority change).

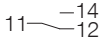
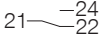
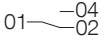
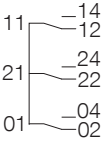
TYPE	TERMINAL NO.	STATUS OF THE CONTACT	DESCRIPTION	OUTPUT CHARACTERISTICS	RECOMMENDED CONNECTION CROSS-SECTION
Auxiliary contact block 1309 1001	11/12/14		Changeover switch in position I	250V AC 5A AC1 24VDC 2A AC13 - 250VAC - 2A	0.5 to 2.5 mm ² (rigid)
	21/22/24		Changeover switch in position II	250V AC 5A AC1 24VDC 2A AC13 - 250VAC - 2A	
	01/02/04		Changeover switch in position 0	250V AC 5A AC1 24VDC 2A AC13 - 250VAC - 2A	
Auxiliary contact block 1309 1011	11/12/14		Changeover switch in position I	250V AC 5A AC1 24VDC 2A AC13 - 250VAC - 2A	0.5 to 1.5 mm ² (stranded)
	21/22/24		Changeover switch in position II	250V AC 5A AC1 24VDC 2A AC13 - 250VAC - 2A	
	01/02/04		Changeover switch in position 0	250V AC 5A AC1 24VDC 2A AC13 - 250VAC - 2A	

12.2. Auxiliary contact operating schedule

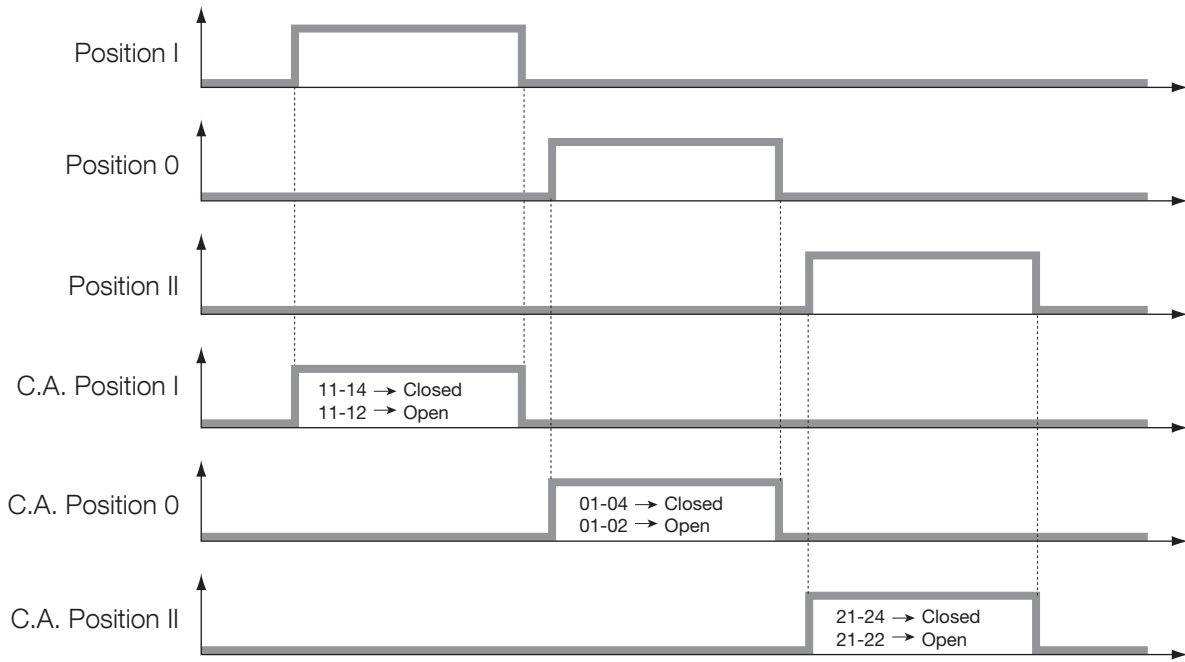

13. OPERATION

13.1. Presentation of the product interface

13.1.1. Product interface

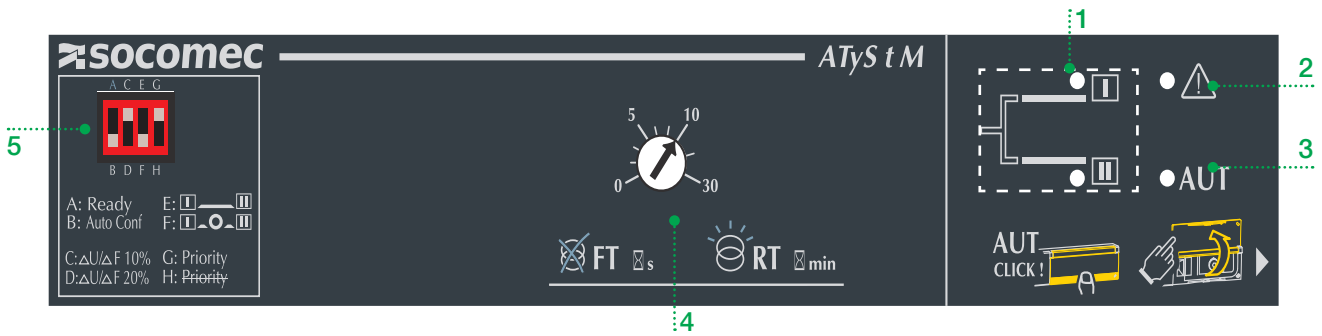

- 1. Source I and Source II availability indicators
- 2. Fault LED
- 3. Auto LED

- 4. Potentiometers to set timers
- 5. Dip switches

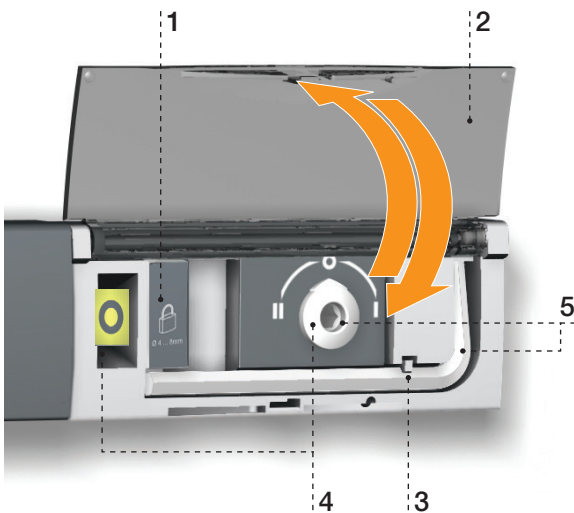

1. Locking

- Option to padlock using a 1 x 8 mm max. padlock.

2. AUT/MAN cover

- Open the cover to switch to manual mode.
- Close the cover to return to automatic (remote control) mode.
- Open and close the cover to clear faults.

3. Auto/Manual mode sensor

4. Switch position indicators

- Display of position I, 0, II.

5. Manual switching

- Insert the Allen key (5.0 mm) provided and turn to switch manually.
- Manual operation is not possible when padlocked.

13.1.2. Reset

Operating fault reset
Open and re-close the AUT/MAN cover

13.2. Manual mode

To access manual mode, open the Aut/Man cover.

Once manual mode is active (cover open) it is possible:

- To lock the changeover switch (padlock).
- To manually operate the changeover switch using the handle.

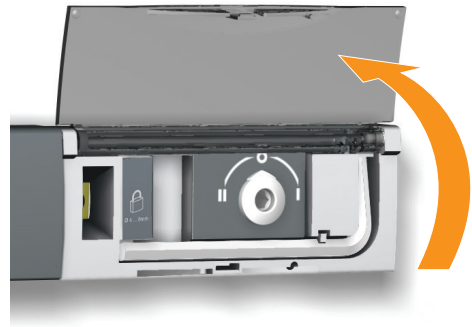

As soon as manual mode is activated, remote orders are inhibited.

MANUAL MODE

Locking

Manual changeover switching

13.2.1. Manual switching

Use the handle situated on the front panel under the cover to manoeuvre the changeover switch. To simplify the operation, it is advised to also use the handle extension that is delivered with the product.

Check the changeover switch position on the indicator situated on the front panel before making any operation.

- From position I, turn anti-clockwise to get to position 0
- From position 0, turn anti-clockwise to get to position II
- From position II, turn clockwise to get to position 0
- From position 0, turn clockwise to get to position I

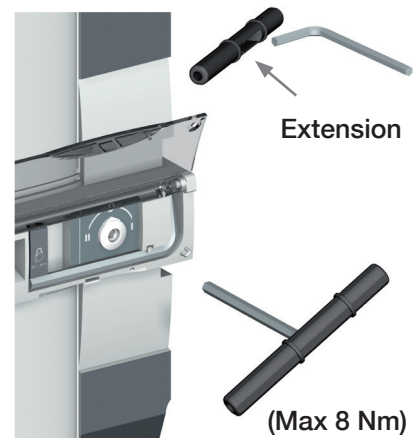

Do not force the product (Max 8 Nm).

13.3. Padlocking

Enables locking in the 0 position (factory configuration) or in positions I, 0 or II (user configurable).

It is necessary to configure padlocking to all positions before installation as access to configuration is at the back of the product. Refer to section «8.1. Changing the padlocking configuration», page 17

13.4. Programming

Whilst in manual mode check the wiring and installation. If ok power up the product.
This product must always be put into service by qualified and approved personal.
The LED signalling is only active when the product supply is on (supply LED lit).
To set the dip switches, it is necessary to open the AUTO/MANU cover.

The commissioning must always result in having at least 1 LED source available lit..

Therefore, the voltage and frequency must be within the defined thresholds.



Any action on the potentiometers changes the settings, even if the cover is closed.

13.4.1. Auto-configuration

Once the product is connected, you can configure automatically its nominal voltage & nominal frequency.
Therefore, while front cover is open:

1. Put dip switch A-B in position B.
2. All leds are blinking.
3. All leds are on, not blinking anymore.
4. Put dip switch A-B in position A: product is ready to work.

The LED signalling and operation is only active when the product supply is available.
To set the dip switches, it is necessary to open the Auto/Manual cover.

13.4.2. Sealable configuration cover

Configuration settings may be protected by means of a sealable cover.
Refer to section «5. Optional accessories», page 11.

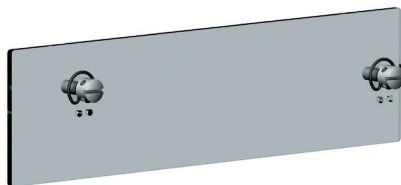

13.5. Automatic mode

Close the cover to enter automatic mode. Make sure that the changeover switch is in automatic mode (AUT LED lit).

13.5.1. Sealable Auto/Manual cover

Auto/Manu mode can be protected by sealing the standard Auto/Manu cover as shown.

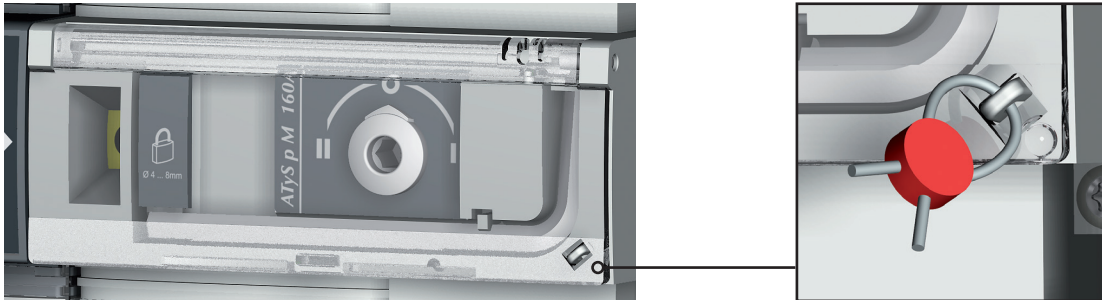

13.6. Possible actions

Once in automatic mode, it is possible to:

- Run a source I / source loss sequence II,
- start a restoration sequence source I / source II.

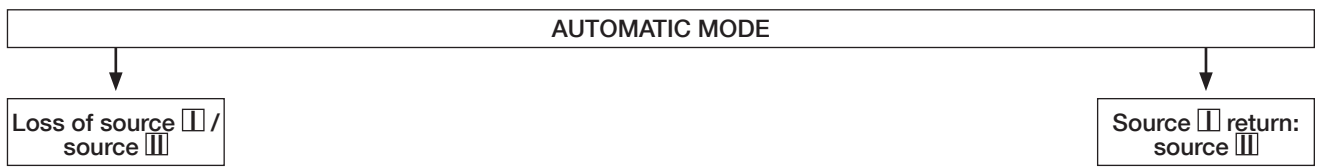

14. PREVENTATIVE MAINTENANCE

It is recommended to operate the product at least once a year.

I - O - II - O - I

Note: Maintenance should be planned carefully and carried out by qualified and authorised personnel. Consideration of the critical level and application where the product is installed should form an essential and integral part of the maintenance plan. Good engineering practice is imperative whilst all necessary precautions must be taken to ensure that the intervention (whether directly or indirectly) remains safe in all aspects.



The use of any Megohmmeter is prohibited on this product as the connection terminals are intrinsically connected to the sensing circuit.

15. TROUBLESHOOTING GUIDE

PROBLEM	ACTIONS	EXPECTED RESULTS
Product is off, i.e. no LEDs are ON.	Check for 176-288VAC across terminals 1 and 7 on switch I and II.	The AUT LED is ON with manual operation cover closed.
SOURCE1 availability LED is OFF.	Voltage and frequency auto configuration: - Step 1: open manual operation cover. - Step 2: set dip switch A-B to position B. - Step 3: when all LEDs are on, return dip switch A-B to position A - Step 4: re-close the cover.	SOURCE 1 LED is ON.
	Check the value of the voltage and frequency thresholds (dip switch C-D). Set to maximum level and reduce later if applicable.	
	Check the following parameters: - network type: Must be a 3 phase network + neutral (or transformer), - nominal voltage: Must be between 176 and 288 Vac, - nominal frequency: Must be between 45 and 65 Hz.	
SOURCE 2 availability LED is OFF.	Voltage and frequency auto configuration: - Step 1: open manual operation cover, - Step 2: set dip switch A-B to position B, - Step 3: when all LEDs are on, return dip switch A-B to position A, - Step 4: re-close the cover.	SOURCE 2 LED is ON.
	Check the value of the voltage and frequency thresholds (dip switch C-D). Set to maximum level and reduce later if applicable.	
	Check the following parameters: - network type: Must be a 3 phase network + neutral (or transformer), - nominal voltage: Must be between 176 and 288 Vac, - nominal frequency: Must be between 45 and 65 Hz.	
Switch remains off after loss of Priority source; i.e. no LEDs are ON.	Check for 176-288VAC across power terminals 1 and 7 on switch II.	The AUT LED is ON with manual operation cover closed.
The switch does not transfer after loss of priority source.	Check that the product is not in manual mode: - Automatic mode = Cover closed - Manual mode = Cover open.	The AUT LED is ON.
	Check that automatic operation has not been inhibited by an external order (terminals 207-210).	The AUT and the backup SOURCE LEDs are ON.
	Check that the backup source is seen as available; appropriate source availability LED is ON. If it is not ON refer to above actions for "SOURCE x availability LED is OFF". Check that automatic operation has not been inhibited by an external order (terminals 207-210).	
	Check FT (Main Failure Timer) configuration, which can be configured between 0 and 30s. The changeover will only take place at the end of FT.	When FT reaches zero the switch will operate to position 0 before finally transferring to its backup position.
The switch does not return to its priority position after the priority source has been restored.	Check that the product is not in manual mode: - Automatic mode = Cover closed, - Manual mode = Cover open.	The AUT LED is ON.
	Check that automatic operation has not been inhibited by an external order (terminals 207-210).	The AUT and the priority SOURCE LEDs are ON.
	Check that the priority source is seen as available; appropriate source availability LED is ON. If it is not ON refer to above actions for "SOURCE x availability LED is OFF".	
	Check RT (Main Return Timer) configuration which can be configured between 0 and 30min. The changeover will only take place at the end of RT.	When RT reaches zero the switch will operate to position 0 before finally transferring to its priority position.

CORPORATE HQ CONTACT:
SOCOMEC SAS
1-4 RUE DE WESTHOUSE
67235 BENFELD, FRANCE

www.socomec.com



542931D

 **socomec**
Innovative Power Solutions